

Valve Catalogue

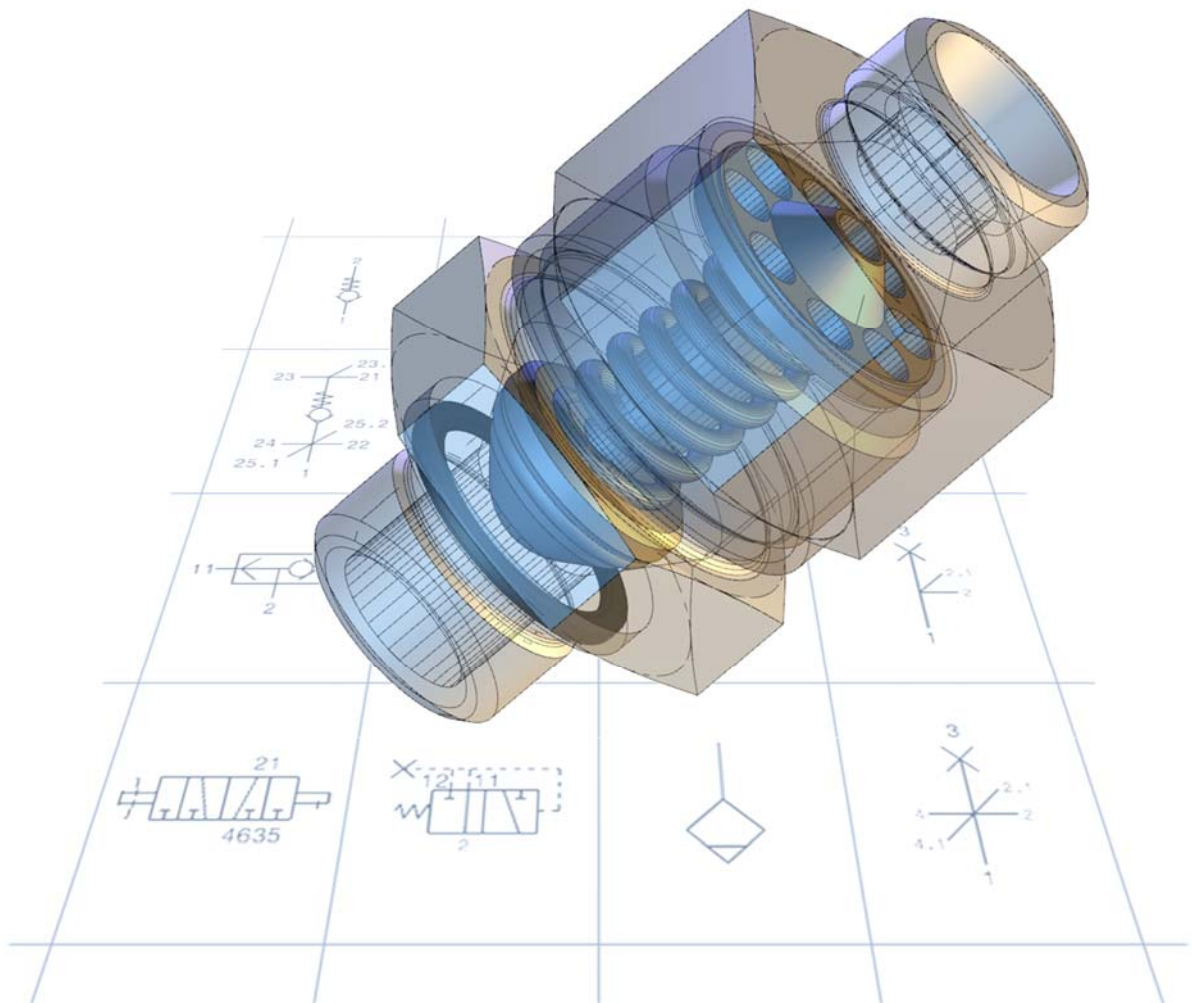

A comprehensive program
as a basis for customized solutions

The standard program

Mechanically controlled valves for pneumatics, fuel, coolant, and engine and hydraulic oil. Valves with other specifications and development of custom-made valves on request.

A. Flow-stop valves	
1. Plug-in couplings 246 with flow-stop	3
2. Adapters 246 with flow-stop	4
3. Studs with flow-stop	5
4. Banjo fittings with flow-stop	6
B. Non-return valves	
1. Screwed non-return valves	7
2. Inline non-return valves	8
3. Quick connect system components with non-return valve	10
4. Banjo bolts with integrated non-return valve	12
5. Manifolds with integrated non-return valve	15
6. Non-return valve cartridges	20
C. Multi-port valves	
1. Two-way valves	21
2. Two-way valves with spring	22
3. Six-way switch valves	23
D. Test and filling valves	
1. Test and filling connections with screw-in thread	24
2. Test and filling connections with screw-on thread	26
3. Straight quick connect system parts with test and filling connection	28
4. Test and filling valves with several branches	29
5. Emergency release connections	33
6. Test valves	34
E. Drain valves	35
F. Special valves	
1. Pressure relief valve for hydraulic motor	36
2. Pressure control valve for air suspension	37
3. Regulating valve for cooling water	38
4. SAE supply connection	39
List of article numbers	40

A. Flow-stop valves

1. Plug-in coupling 246 with flow-stop

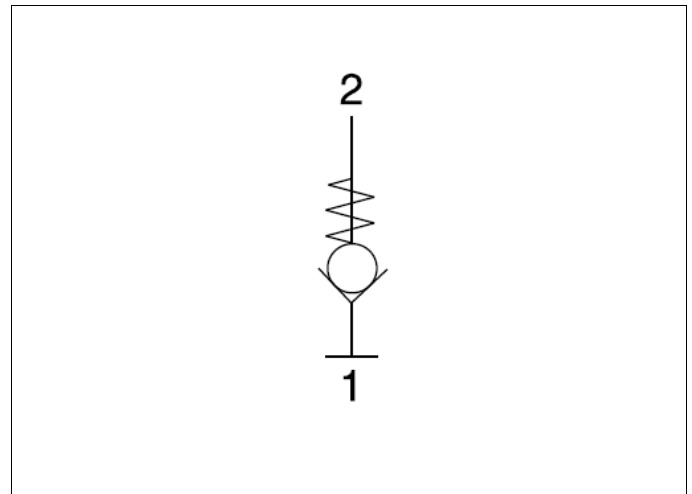

Part number	Connections	Working press. (max)	Application temperature	Construction	Housing material	Sealing material	Application medium	Rem.
5246021800	1 Profile SV246 NS8 2 Fir-tree NS6	8 bar	-40°C to +100°C	Press-fitted valve unit with O-ring	Nylon	FPM	Diesel fuel	
5246036100	1 Profile SV246 NS8 2 Fir-tree NS6	8 bar	-40°C to +100°C	Press-fitted valve unit with O-ring	Nylon	EPDM	Cooling water	
5246033900	1 Profile SV246 NS12 2 Fir-tree NS7,5	8 bar	-40°C to +100°C	Press-fitted valve unit with O-ring	Nylon	FPM	Diesel fuel	
5246063900	1 Profile SV246 NS12 2 Fir-tree NS9	8 bar	-40°C to +100°C	Press-fitted valve unit with O-ring	Nylon	FPM	Diesel fuel	
5246013000	1 Profile SV246 NS12 2 Fir-tree NS10	8 bar	-40°C to +100°C	Press-fitted valve unit with O-ring	Nylon	FPM	Diesel fuel	
5246037300	1 Profile SV246 NS12 2 Fir-tree NS12 (5/8")	8 bar	-40°C to +100°C	Press-fitted valve unit with O-ring	Nylon	FPM	Diesel fuel	

A. Flow-stop valves

2. Adapters 246 with flow-stop

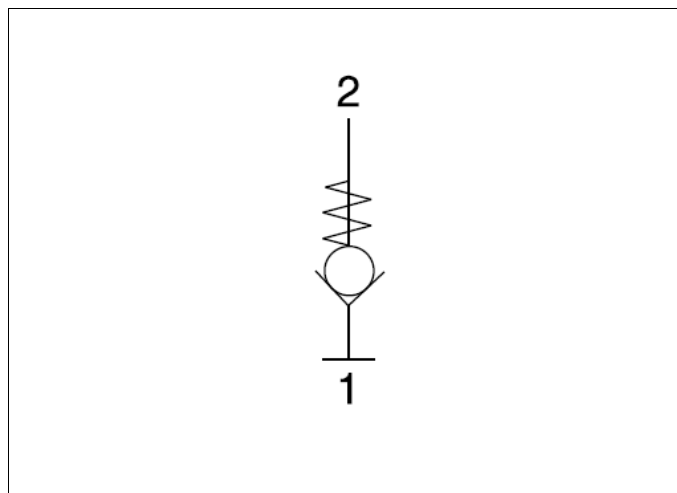

Part number	Connections	Working press. (max)	Application temperature	Construction	Housing material	Sealing material	Application medium	Rem.
5246016249	1 Profile SV246 NS8 2 Male thread M12x1.5 AF22 completely with copper washer	8 bar	-40°C to +100°C	Tappet with O-ring	Brass	FPM	Diesel fuel	
5246030700	1 Profile SV246 NS8 2 Male thread M12x1.5 AF22 with O-ring sealing to ISO 6149	8 bar	-40°C to +100°C	Tappet with O-ring	Brass	FPM	Cooling water	
5246047649	1 Profile SV246 NS8 2 Male thread M12x1.5 AF22 completely with copper washer	8 bar	-40°C to +100°C	Tappet with O-ring	Steel	EPDM	Cooling water	
5246031100	1 Profile SV246 NS8 2 Male thread 3/8 NPT AF22	8 bar	-40°C to +100°C	Tappet with O-ring	Brass	FPM	Diesel fuel	
5246014649	1 Profile SV246 NS12 2 Male thread M16x1.5 AF27, completely with copper washer	8 bar	-40°C to +100°C	Tappet with O-ring	Brass	FPM	Diesel fuel	
5246042900	1 Profile SV246 NS12 2 Male thread M16x1.5 AF27 O-ring sealing with angular O-ring groove	8 bar	-40°C to +100°C	Tappet with O-ring	Brass	FPM	Diesel fuel	
5246040349	1 Profile SV246 NS12 2 Male thread M18x1.5 AF27 completely with copper washer	8 bar	-40°C to +100°C	Tappet with O-ring	Brass	FPM	Diesel fuel	
5246038052	1 Profile SV246 NS12 2 Male thread M18x1.5 AF27 O-ring sealing with angular O-ring groove	8 bar	-40°C to +100°C	Tappet with O-ring	Brass	FPM	Diesel fuel	

A. Flow-stop valves

3. Studs with flow stop

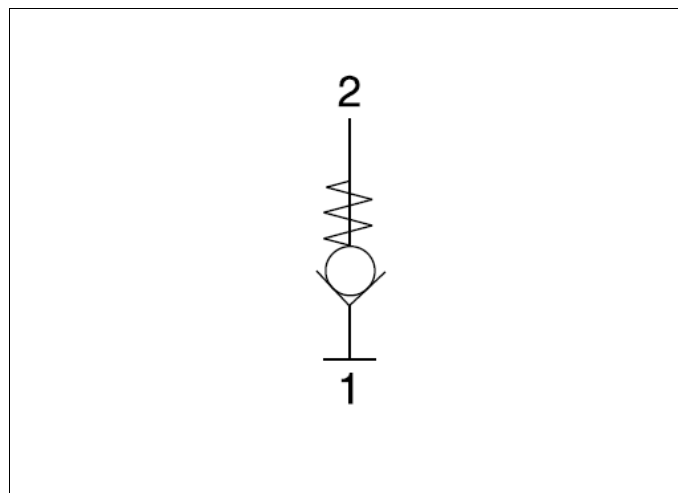

Part number	Connections	Working press. (max)	Application temperature	Construction	Housing material	Sealing material	Application medium	Rem.
5466071200	1 Male thread M18x1.5 ID12.2 2 Fir-tree NS10	10 bar	-40°C to +120°C	Press-fitted valve unit with O-ring	Steel	FPM	Diesel fuel	
5466002500	1 Male thread M18x1.5 ID12.6 2 Fir-tree NS10	10 bar	-40°C to +120°C	Tappet with O-ring	Steel	FVMQ	Diesel fuel	
5466208800	1 Male thread M22x1.5 ID15.6 2 Hose connection DN9	5 bar	-40°C to +100°C	Press-fitted valve unit with O-ring	Steel	FPM	Diesel fuel	
5466095500	1 Male thread M22x1.5 ID15.6 2 Male thread M14x1.5 with sealing for copper ring to DIN 3852 Form A	5 bar	-40°C to +120°C	Press-fitted valve unit with O-ring	Steel	FPM	Diesel fuel	
5466186800	1 Male thread M22x1.5 ID15.6 with closing plug 2 Male thread M22x1.5 with sealing for copper ring to DIN 3852 Form A	12 bar with closing plug, 5 bar with flow stop	-40°C to +120°C	Press-fitted valve unit with O-ring	Steel	FPM	Motor oil	
5466208900	1 Male thread M24x1.5 ID15.6 2 Hose connection DN12	5 bar	-40°C to +100°C	Press-fitted valve unit with O-ring	Steel	FPM	Diesel fuel	
5466095600	1 Male thread M24x1.5 ID15.6 2 Male thread M22x1.5 ID9 with sealing for copper ring to DIN 3852 Form A	5 bar	-40°C to +120°C	Press-fitted valve unit with O-ring	Steel	FPM	Diesel fuel	
5466118400	1 Male thread M24x1.5 ID15.6 2 Male thread M22x1.5 ID10 with sealing for copper ring to DIN 3852 Form A	5 bar	-40°C to +120°C	Press-fitted valve unit with O-ring	Steel	FPM	Diesel fuel	

A. Flow-stop valves

4. Banjo fittings with flow-stop or non-return valve

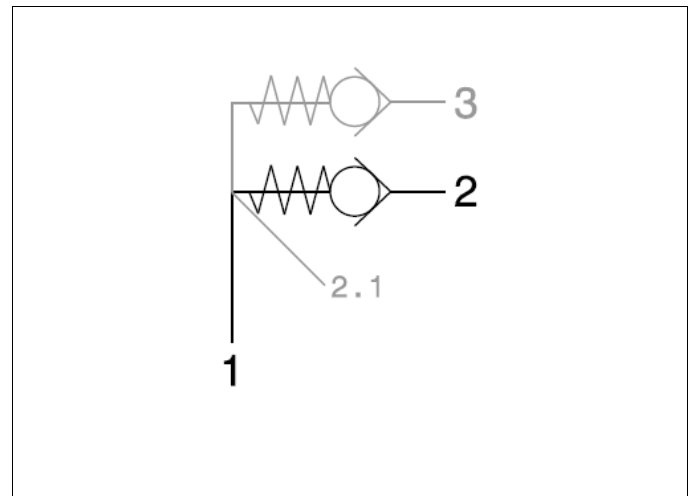
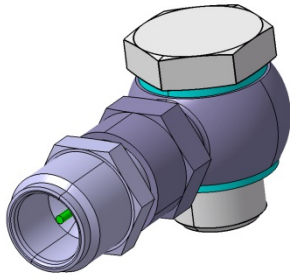

Part number	Connections	Working press. (max)	Application temperature	Construction	Housing material	Sealing material	Application medium	Rem.
5466000600	1 Banjo fitting with hollow bolt M16x1.5 2 Fir-tree NS8 2.1 Fir-tree NS8	10 bar	-40°C to +120°C	Non-return valve	Steel	FVMQ	Diesel fuel	
5466001600	1 Banjo fitting with hollow bolt M16x1.5 2 Male thread M18x1.5 ID12.6	10 bar	-40°C to +120°C	Flow-stop valve	Steel	FVMQ	Diesel fuel	
5466029149	1 2 x banjo fitting with double hollow bolt M16x1.5 2 Male thread M18x1.5 ID12.6 3 Male thread M18x1.5 ID12.6 90°	10 bar	-40°C to +120°C	Flow-stop valve	Steel	FVMQ	Diesel fuel	

B. Non-return valves

1. Screwed non-return valves

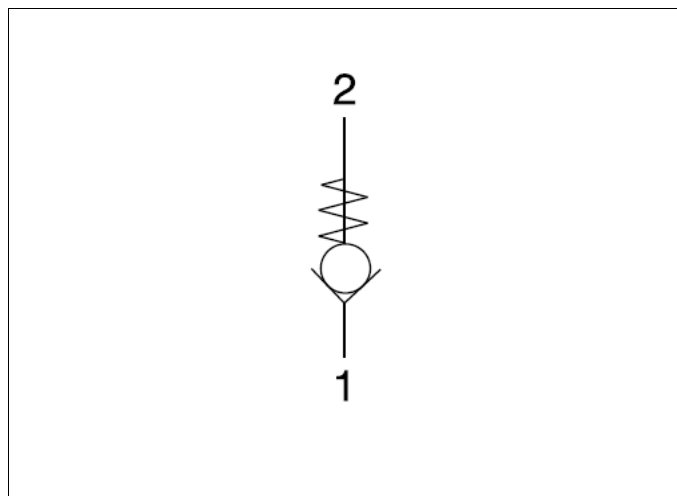
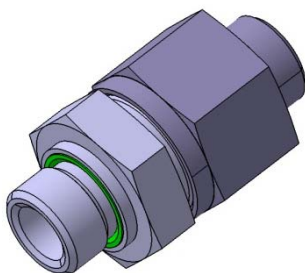

Part number	Connections	Opening pressure	Working press. (max)	Application temperature	Construction	Housing material	Sealing material	Application medium	Rem.
0671410L00	1 Screw-in thread M12x1.5 with sealing for copper ring 2 Female thread M12x1.5	5 bar	50 bar	-40°C to +130°C	Tappet with O-ring	Stainless steel	FPM	Diesel fuel	1)
0601322007	1 Screw-in thread M14x1.5 with PFLEX sealing 2 Cutting ring L10 M16x1.5 with nut and cutting ring	1 bar	250 bar	-40°C to +90°C	Tappet with O-ring	Steel	NBR	Hydraulic oils on the basis of mineral oil	
0671423E13	1 Screw-in thread M16x1.5 with sieve insert, with sealing for copper ring 2 Female thread M16x1.5	4.5 bar	50 bar	-40°C to +130°C	Tappet with throttling port D 0.5	Stainless steel	Metallically sealing	Diesel fuel	1)
5690020300	1 Screw-in thread M16x1.5 with sieve insert, with O-ring sealing on the face side 2 Female thread M16x1.5	0.2 bar	13 bar	-40°C to +80°C	Sealing disc	Steel	NBR	Compressed air	
0667382081	1 Screw-in thread M22x1.5 with PFLEX sealing 2 Cutting ring L15 M22x1.5	6 bar	160 bar	-40°C to +90°C	Tappet with O-ring	Steel	NBR	Hydraulic oils on the basis of mineral oil	
0670502020	1 Screw-in thread M26x1.5 with PFLEX sealing 2 cutting ring L22 M30x2	0.2 bar	160 bar	-40°C to +90°C	Tappet with O-ring	Steel	NBR	Hydraulic oils on the basis of mineral oil	
0671832020	1 Screw-in thread G1¼" with PFLEX sealing 2 Cutting ring L28 M36x2	0.2 bar	100 bar	-40°C to +90°C	Tappet with O-ring	Steel	NBR	Hydraulic oils on the basis of mineral oil	

1) for high cleanliness requirements

B. Non-return valves

2. Inline non-return valves, part 1

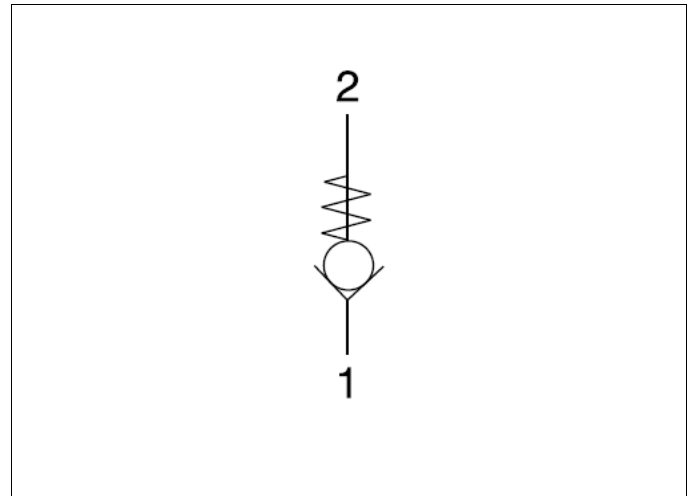
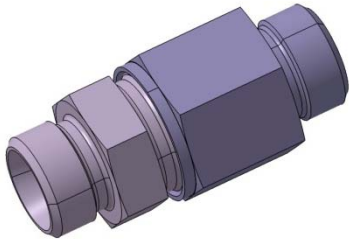

Part number	Connections	Opening pressure	Working press. (max)	Application temperature	Construction	Housing material	Sealing material	Application medium	Rem.
0667012081	1 Cutting ring L12 M18x1.5 2 Cutting ring L12 M18x1.5	0.3 bar	250 bar	-40° to +90°	Tappet with O-ring	Steel	NBR	Diesel fuel Hydraulic oils on the basis of mineral oil	
0669522081	1 Cutting ring L12 M18x1.5 2 Cutting ring L12 M18x1.5	0.3 bar	250 bar	-40° to + 100°	Tappet	Steel	Metallically sealing	Diesel fuel Hydraulic oils on the basis of mineral oil	
0668662000	1 Cutting ring L15 M22x1.5 2 Cutting ring L15 M22x1.5	0.2 bar	250 bar	-40° to +100°	Tappet with O-ring	Steel	NBR	Diesel fuel Hydraulic oils on the basis of mineral oil	
0600962000	1 Cutting ring L18 M26x1.5 2 Cutting ring L18 M26x1.5	0.05 bar	160 bar	-40° to +100°	Tappet with O-ring	Steel	NBR	Diesel fuel Hydraulic oils on the basis of mineral oil	
0600942081	1 Cutting ring L18 M26x1.5 2 Cutting ring L18 M26x1.5	0.15 bar	160 bar	-40° to +100°	Tappet with O-ring	Steel	NBR	Diesel fuel Hydraulic oils on the basis of mineral oil	
0667522007	1 Cutting ring L18 M26x1.5 with nut and cutting ring 2 Cutting ring L18 M26x1.5 with nut and cutting ring	0.05 bar	160 bar	-40° to +100°	Tappet with O-ring	Steel	FPM	Diesel fuel Hydraulic oils on the basis of mineral oil	
0671690D00	1 Ball bearing M14x1.5 for tube OD8 2 Female thread M12x1.5	3.75 bar	30 bar	-40° to +130°	Tappet with O-ring	Stainless steel	FPM	Diesel fuel	1)
0671610L00	1 Ball bearing M14x1.5 for tube OD8 2 Female thread M12x1.5	6.2 bar	50 bar	-40° to +130°	Tappet with O-ring	Stainless steel	FPM	Diesel fuel	1)

1) for high cleanliness requirements

B. Non-return valves

2. Inline non-return valves, part 2

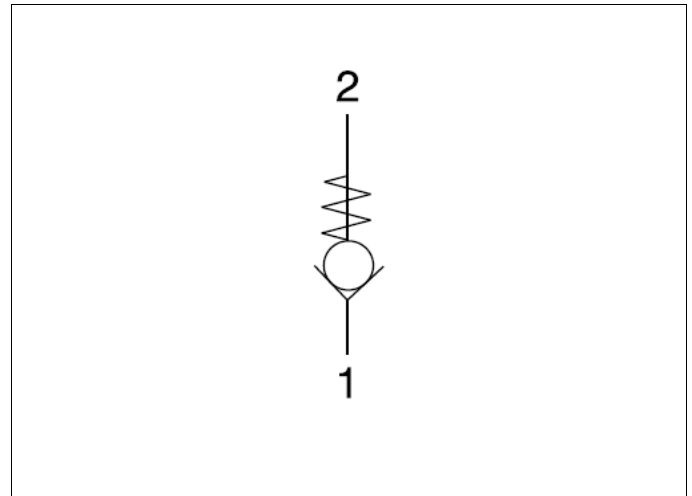
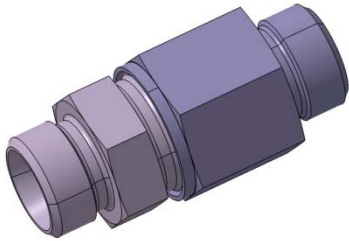

Part number	Connections	Opening pressure	Working press. (max)	Application temperature	Construction	Housing material	Sealing material	Application medium	Rem.
0669862020	<ul style="list-style-type: none"> 1 Ball bearing M16x1.5 for tube OD10 2 Ball bearing M16x1.5 for tube OD10 	0.2 bar	25 bar	-40° to +100°	Tappet with O-ring	Steel	FPM	Diesel fuel	
0670192020	<ul style="list-style-type: none"> 1 Ball bearing M18x1.5 for tube OD12 2 Ball bearing M18x1.5 for tube OD12 	0.2 bar	25 bar	-40° to +100°	Tappet with O-ring	Steel	FPM	Diesel fuel	
0670202020	<ul style="list-style-type: none"> 1 Ball bearing M22x1.5 for tube OD15 2 Ball bearing M22x1.5 for tube OD15 	0.2 bar	25 bar	-40° to +100°	Tappet with O-ring	Steel	FPM	Diesel fuel	
5466087900	<ul style="list-style-type: none"> 1 Drive-in mandrel for PA tube NS12 2 Drive-in mandrel for PA tube NS12 	0.2 bar	12 bar	-40° to +100°	Tappet with O-ring	Steel	FPM	Diesel fuel	

B. Non-return valves

3. Quick connect system components with non-return valve, part 1

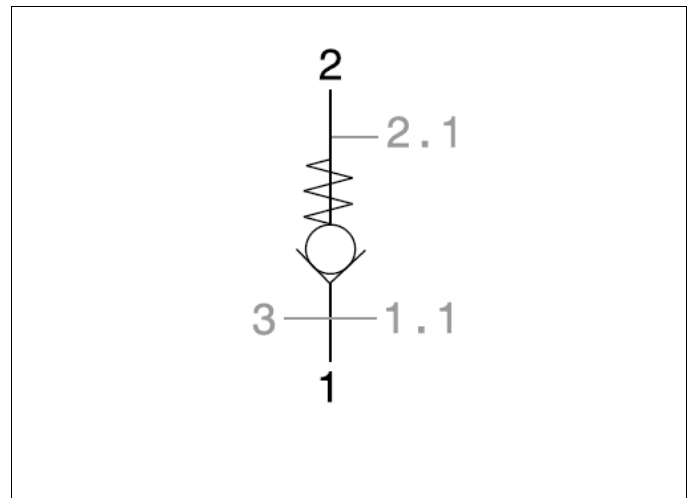
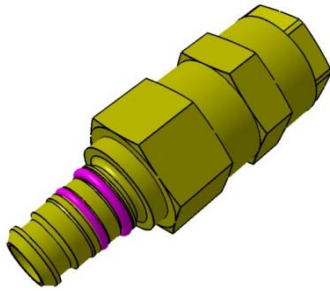

Part number	Connections	Opening pressure	Working press. (max)	Application temperature	Construction	Housing material	Sealing material	Application medium	Rem.
5232821149	1 Plug SV232 NS12 2 Coupling SV232 NS12	0.2 bar	15.5 bar	-40°C to +100°C	Sealing disc	Brass	NBR	Compressed air	
5232821049	1 Plug SV232 NS12 2 Coupling SV232 NS12 with non-return valve 3 Coupling SV232 NS12	0.2 bar	15.5 bar	-40°C to +100°C	Sealing disc	Brass	NBR	Compressed air	
5232821400	1 Screw-in thread M22x1.5 with O-ring for profiled bore SV230/232 2 Coupling SV232 NS12	0.2 bar	13 bar	-40°C to +100°C	Sealing disc	Brass	NBR	Compressed air	
5232820049	1.1 Bulkhead thread M22x1.5 2 Coupling SV232 NS12	0.2 bar	15.5 bar	-40°C to +100°C	Sealing disc	Brass	NBR	Compressed air	
5232820070	1 Bulkhead thread M22x1.5 with hexagonal sealing nut 2 Coupling SV232 NS12	0.2 bar	15.5 bar	-40°C to +100°C	Sealing disc	Brass	NBR	Compressed air	
5232993100	1 Cutting ring L6 M12x1.5 and bulkhead thread M16x1.5 2 Coupling SV232 NS8	0.2 bar	15.5 bar	-40°C to +130°C	Tappet	Brass	FPM	Compressed air	
0233255000	1 Profiled bore SV230/232 NS8 M16x1.5 2.1 Male thread M12x1.5	0.2 bar	15.5 bar	-40°C to +100°C	Tappet	Brass	FPM	Compressed air	
5246066200	1 Male thread M18x1.5 O-ring sealing with angular O-ring groove 2.1 Profile SV246 NS8	7 bar	8 bar	-40°C to +130°C	Tappet	Steel	Metallically sealing	Diesel fuel	

B. Non-return valves

3. Quick connect system components with non-return valve, part 2

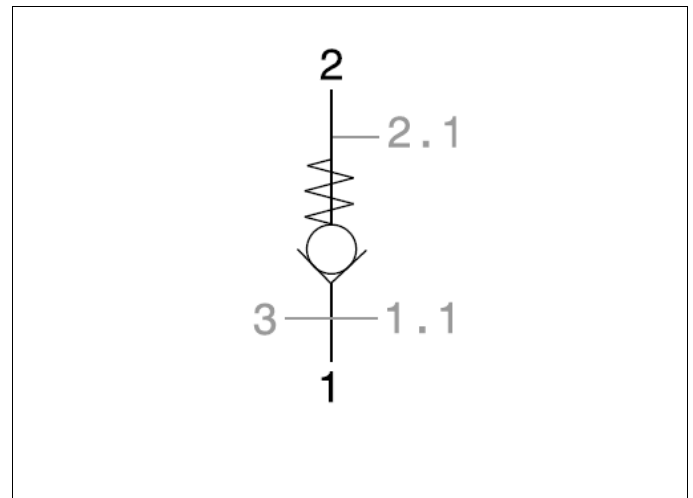
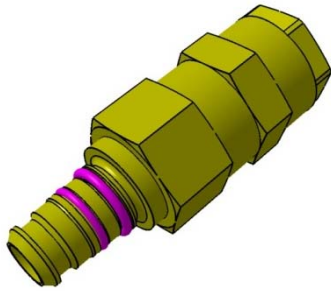

Part number	Connections	Opening pressure	Working press. (max)	Application temperature	Construction	Housing material	Sealing material	Application medium	Rem.
5246066800	1 Male thread M18x1.5 O-ring sealing with angular O-ring groove	5.35 bar	8 bar	-40°C to +130°C	Tappet	Steel	Metallically sealing	Diesel fuel	
	2.1 Profile SV246 NS8								

B. Non-return valves

4. Banjo bolts with integrated non-return valve, part 1

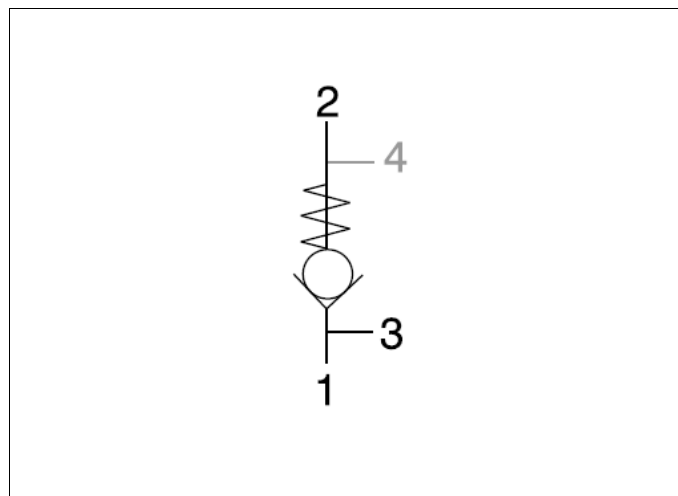
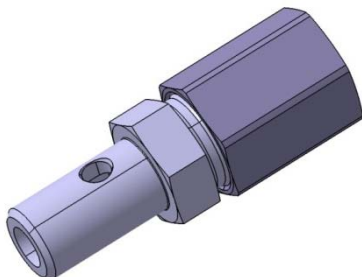

Part number	Connections	Opening pressure	Working press. (max)	Application temperature	Construction	Housing material	Sealing material	Application medium	Rem.
5690021400	2 Banjo bolt M10x1 3 Outlet port 1 x D2 for banjo fitting ND10	0.2 bar	15 bar	-40°C to +130°C	Tappet with O-ring	Steel	FPM	Diesel fuel	
0670512000	1 Banjo bolt M12x1.5 with throttling port D2 2 Female thread M12x1.5 3 Outlet port 3 x D4.5 for banjo fitting ND12	4.8 bar	12 bar	-40°C to +130°C	Tappet	Steel	Metallically sealing	Diesel fuel	
0670992000	1 Banjo bolt M12x1.5 with throttling port D2 2 Female thread M 12x1.5 3 Outlet port 3 x D4.5 for banjo fitting ND12	4.5 bar	50 bar	-40°C to +130°C	Tappet	Steel	Metallically sealing	Diesel fuel	1)
0671630L00	1 Banjo bolt M12x1.5 with throttling port D2 2 Female thread M12x1.5 3 Outlet port 3 x D4.5 for banjo fitting ND12	4.5 bar	50 bar	-40°C to +130°C	Tappet with O-ring	Steel	FPM	Diesel fuel	1)
0660242000	2 Banjo bolt M14x1.5 3 Banjo bolt M14x1.5	5.5 bar	250 bar	-40°C to +130°C	Tappet with throttling port	Steel	Metallically sealing	Diesel fuel	2)
0660252000	2 Banjo bolt M14x1.5 3 Banjo bolt M14x1.5	5.2 bar	250 bar	-40°C to +130°C	Tappet with throttling port	Steel	Metallically sealing	Diesel fuel	2)
5690021300	2 Banjo bolt M14x1.5 3 Outlet port 1 x D2 for banjo fitting ND14	0,2 bar	15 bar	-40°C to +130°C	Tappet with O-ring	Brass	FPM	Diesel fuel	

1) for high cleanliness requirements

2) flange-mount T valve body

B. Non-return valves

4. Banjo bolts with integrated non-return valve, part 2

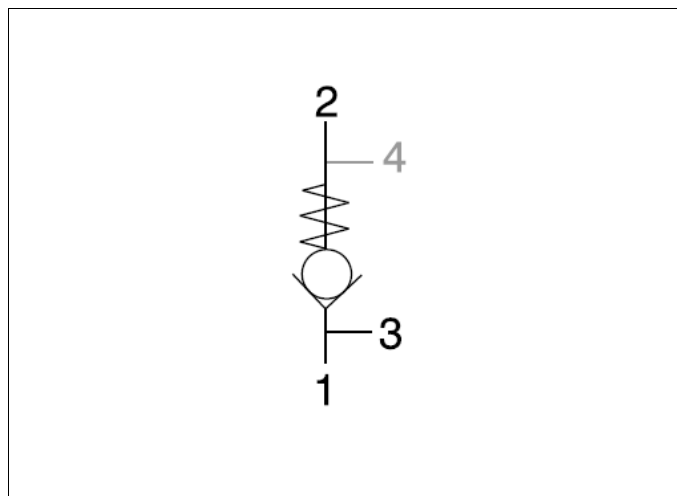
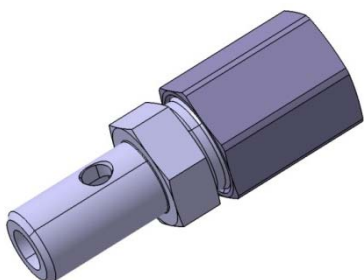

Part number	Connections	Opening pressure	Working press. (max)	Application temperature	Construction	Housing material	Sealing material	Application medium	Rem.
0669732018	1 Banjo bolt M16x1.5 with throttling port D 2,2 2 Female thread M16x1.5 3 Outlet port 1 x D1 for banjo fitting ND16	2 bar	50 bar	-40°C to +130°C	Tappet	Steel	Metallically sealing	Diesel fuel	
0669462000	1 Banjo bolt M16x1.5 with throttling port D 3,1 2 Female thread M16x1.5 3 Outlet port 2 x D6 for banjo fitting ND16	2.65 bar	50 bar	-40°C to +130°C	Tappet	Steel	Metallically sealing	Diesel fuel	
0670942000	1 Banjo bolt M16x1.5 with throttling port D4 2 Female thread M16x1.5 3 Outlet port 2 x D6 for banjo fitting ND16	4.5 bar	50 bar	-40°C to +130°C	Tappet with throttling port D 0,5	Steel	Metallically sealing	Diesel fuel	
0671012023	1 Banjo bolt M16x1.5 with throttling port D4 2 Female thread M16x1.5 3 Outlet port 2 x D6 for banjo fitting ND16	4.5 bar	50 bar	-40°C to +130°C	Tappet with throttling port D 0,5	Steel	Metallically sealing	Diesel fuel	1)
0671291E23	1 Banjo bolt M16x1.5 with sieve insert and throttling port D4 2 Female thread M16x1.5 3 Outlet port 2 x D6 for banjo fitting ND16	4.5 bar	50 bar	-40°C to +130°C	Tappet with throttling port D 0,5	Steel	Metallically sealing	Diesel fuel	1)
0671182023	1 Banjo bolt M16x1.5 with throttling port D5 2 Female thread M16x1.5 3 Outlet port 1 x D1 for banjo fitting ND16	4.5 bar	50 bar	-40°C to +130°C	Tappet	Steel	Metallically sealing	Diesel fuel	

1) for high cleanliness requirements

B. Non-return valves

4. Banjo bolts with integrated non-return valve, part 3

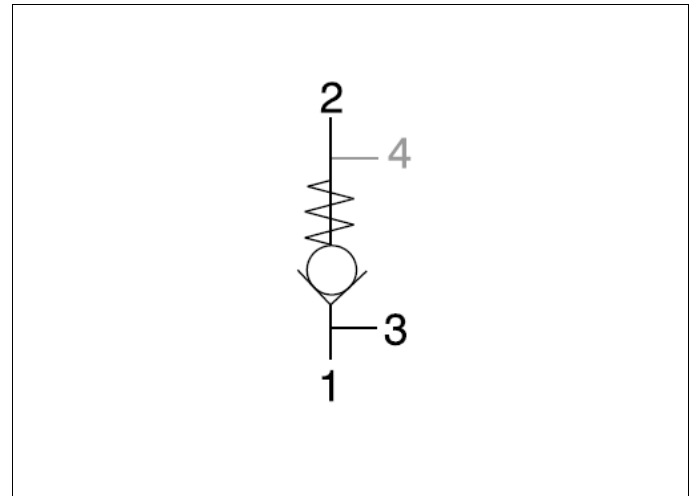
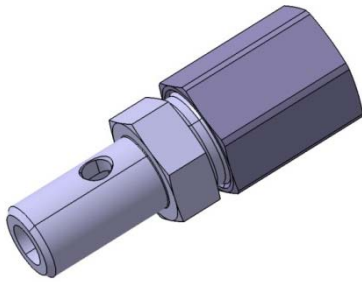

Part number	Connections	Opening pressure	Working press. (max)	Application temperature	Construction	Housing material	Sealing material	Application medium	Rem.
0671522000	1 Banjo bolt D15.95 with O-ring M20x1.5 and screw-in thread 4 Outlet port 4x3 for component bore D16	1 bar	50 bar	-30°C to +140°C	Tappet	Steel	Metallically sealing	Diesel fuel	1)
0671672000	1 Banjo bolt D20 with O-ring M26x1.5 and screw-in thread 4 Outlet port 2 x D6 for component bore D20	3 bar	50 bar	-40°C to +130°C	Tappet	Steel	Metallically sealing	Diesel fuel	

1) for high cleanliness requirements

B. Non-return valves

5. Manifolds with integrated non-return valve, part 1

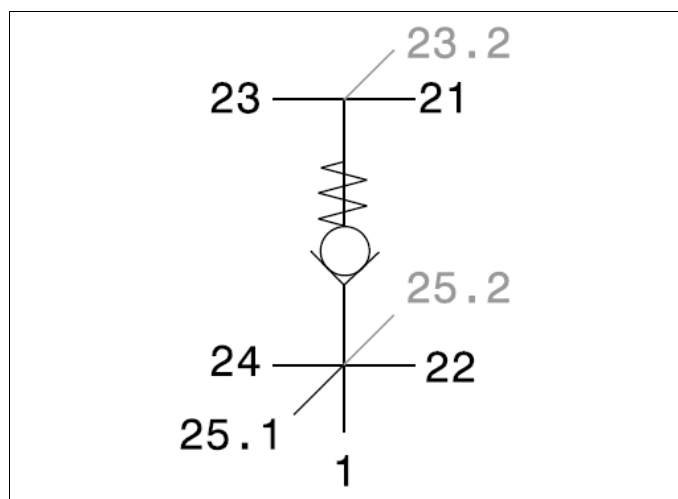
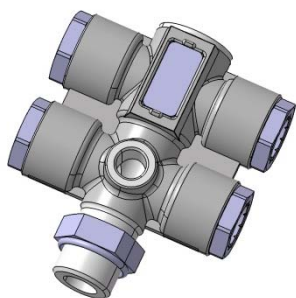

Part number	Connections	Opening pressure	Working press. (max)	Application temperature	Construction	Housing material	Sealing material	Application medium	Rem.
0233124200	1 Coupling SV230 NS12	0.2 bar	13 bar	-40°C to +100°C	Sealing disc	Zinc die-cast	NBR	Compressed air	1)
	21 Coupling SV230 NS12								
	22 Coupling SV230 NS12								
	23 Coupling SV230 NS12								
	24 Female thread M12x1.5								
0233264200	1 Male thread M22x1.5	0.3 bar	15.5 bar	-40°C to +100°C	Sealing disc	Aluminum forging	NBR	Compressed air	
	21 Profiled bore M22x1.5 SV230/232 NS12								
	22 Profiled bore M22x1.5 SV230/232 NS12								
	23 Profiled bore M22x1.5 SV230/232 NS12								
	24 Profiled bore M22x1.5 SV230/232 NS12								
	25.1 Female thread M12x1.5								
0233304200	1 Male thread M22x1.5	0.2 bar	15.5 bar	-40°C to +100°C	Sealing disc	Aluminum forging	NBR	Compressed air	
	21 Profiled bore M22x1.5 SV230/232 NS12								
	22 Profiled bore M22x1.5 SV230/232 NS12								
	23.2 Profiled bore M22x1.5 SV230/232 NS12								
	25.2 Female thread M12x1.5								
0233314249	1 Male thread M22x1.5	0.2 bar	13 bar	-40°C to +100°C	Sealing disc	Aluminum forging	NBR	Compressed air	
	21 Coupling SV230 NS12								
	22 Coupling SV230 NS12								
	23 Coupling SV230 NS12								
	24 Coupling SV230 NS12								

1) 2 fastening bores ID 9 mm

B. Non-return valves

5. Manifolds with integrated non-return valve, part 2

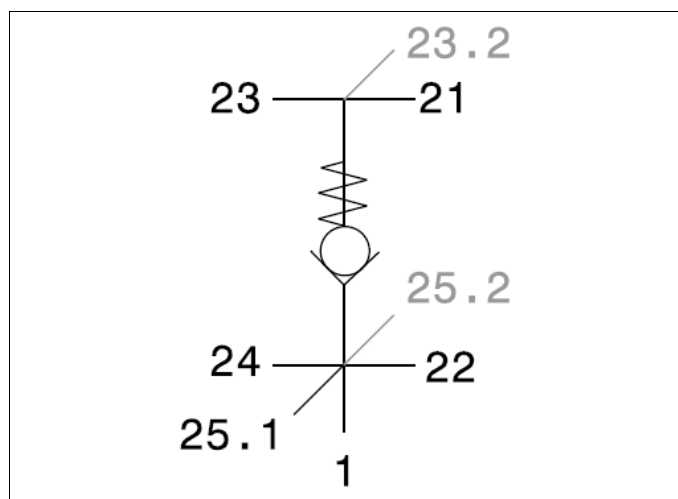
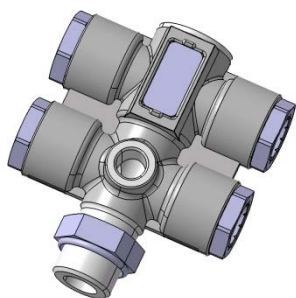

Part number	Connections	Opening pressure	Working press. (max)	Application temperature	Construction	Housing material	Sealing material	Application medium	Rem.
0233324249	<ul style="list-style-type: none"> 1 Male thread M22x1.5 21 Coupling SV230 NS12 22 Coupling SV230 NS12 23.2 Coupling SV230 NS12 	0.2 bar	13 bar	-40°C to +100°C	Sealing disc	Aluminum forging	NBR	Compressed air	
0233334200	<ul style="list-style-type: none"> 1 Male thread M22x1.5 21 Profiled bore M22x1.5 SV230/232 NS12 22 Profiled bore M22x1.5 SV230/232 NS12 23 Profiled bore M22x1.5 SV230/232 NS12 24 Female thread M12x1.5 	0.2 bar	15.5 bar	-40°C to +100°C	Sealing disc	Aluminum forging	NBR	Compressed air	
0268734200	<ul style="list-style-type: none"> 1 Female thread M16x1.5 21 Female thread M16x1.5 23 Female thread M16x1.5 	0.2 bar	13 bar	-40°C to +100°C	Sealing disc	Aluminum forging	NBR	Compressed air	
0268904200	<ul style="list-style-type: none"> 1 Male thread M22x1.5 and Female thread M14x1.5 21 Female thread M22x1.5 22 Female thread M22x1.5 23 Female thread M22x1.5 24 Female thread M22x1.5 25.1 Female thread M12x1.5 	0.2 bar	13 bar	-40°C to +100°C	Sealing disc	Aluminum forging	NBR	Compressed air	

B. Non-return valves

5. Manifolds with integrated non-return valve, part 3

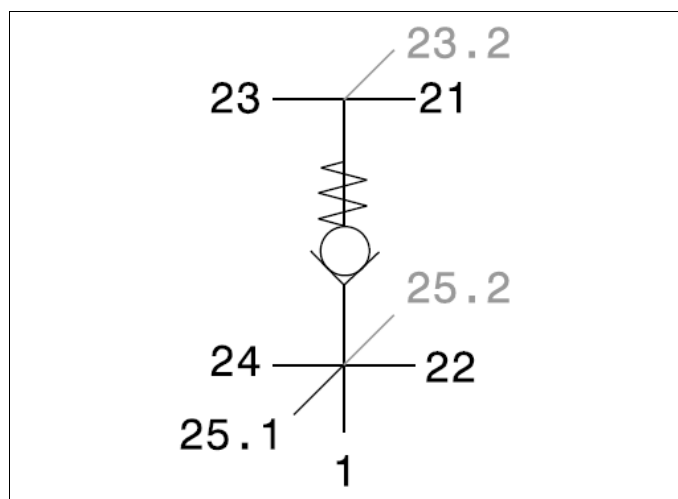
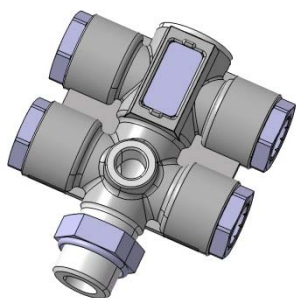

Part number	Connections	Opening pressure	Working press. (max)	Application temperature	Construction	Housing material	Sealing material	Application medium	Rem.
0833124200	1 Profiled bore M22x1.5 SV230/232 NS12	0.2 bar	13 bar	-40°C to +100°C	Sealing disc	Zinc die-cast	NBR	Compressed air	1)
	21 Profiled bore M22x1.5 SV230/232 NS12								
	22 Profiled bore M22x1.5 SV230/232 NS12								
	23 Profiled bore M22x1.5 SV230/232 NS12								
	24 Female thread M12x1.5								
5232820249	1 Male thread M22x1.5	0.3 bar	15.5 bar	-40°C to +100°C	Sealing disc	Aluminum forging	NBR	Compressed air	
	21 Coupling SV232 NS12								
	22 Coupling SV232 NS12								
	23 Coupling SV232 NS12								
	24 Coupling SV232 NS12								
25.1 Female thread M12x1.5									
5232820270	1 Male thread M22x1.5 completed with hexagonal sealing nut and O-ring	0.3 bar	15.5 bar	-40°C to +100°C	Sealing disc	Aluminum forging	NBR	Compressed air	
	21 Coupling SV232 NS12								
	22 Coupling SV232 NS12								
	23 Coupling SV232 NS12								
	24 Coupling SV232 NS12								
25.1 Female thread M12x1.5									
5232820300	1 Coupling SV232 NS12	0.2 bar	13 bar	-40°C to +100°C	Sealing disc	Zinc die-cast	NBR	Compressed air	1)
	21 Coupling SV232 NS12								
	22 Coupling SV232 NS12								
	23 Coupling SV232 NS12								
24 Female thread M12x1.5									

1) 2 fastening bores ID 9 mm

B. Non-return valves

5. Manifolds with integrated non-return valve, part 4

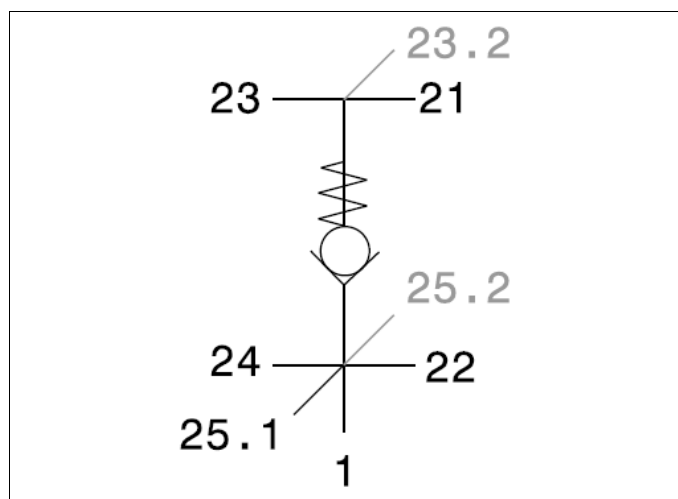
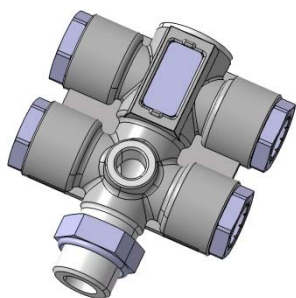

Part number	Connections	Opening pressure	Working press. (max)	Application temperature	Construction	Housing material	Sealing material	Application medium	Rem.
5232820449	1 Male thread M22x1.5 21 Coupling SV232 NS12 22 Coupling SV232 NS12 23.2 Coupling SV232 NS12 25.2 Female thread M12x1.5	0.2 bar	15.5 bar	-40°C to +100°C	Sealing disc	Aluminum forging	NBR	Compressed air	
5232820470	1 Male thread M22x1.5 completed with hexagonal sealing nut and O-ring 21 Coupling SV232 NS12 22 Coupling SV232 NS12 23.2 Coupling SV232 NS12 25.2 Female thread M12x1.5	0.2 bar	15.5 bar	-40°C to +100°C	Sealing disc	Aluminum forging	NBR	Compressed air	
5232820500	1 Male thread M22x1.5 21 Coupling SV232 NS12 22 Coupling SV232 NS12 23 Coupling SV232 NS12 24 Coupling SV232 NS12	0.2 bar	15.5 bar	-40°C to +100°C	Sealing disc	Aluminum forging	NBR	Compressed air	
5232820570	1 Male thread M22x1.5 completed with hexagonal sealing nut and O-ring 21 Coupling SV232 NS12 22 Coupling SV232 NS12 23 Coupling SV232 NS12 24 Coupling SV232 NS12	0.2 bar	15.5 bar	-40°C to +100°C	Sealing disc	Aluminum forging	NBR	Compressed air	

B. Non-return valves

5. Manifolds with integrated non-return valve, part 5

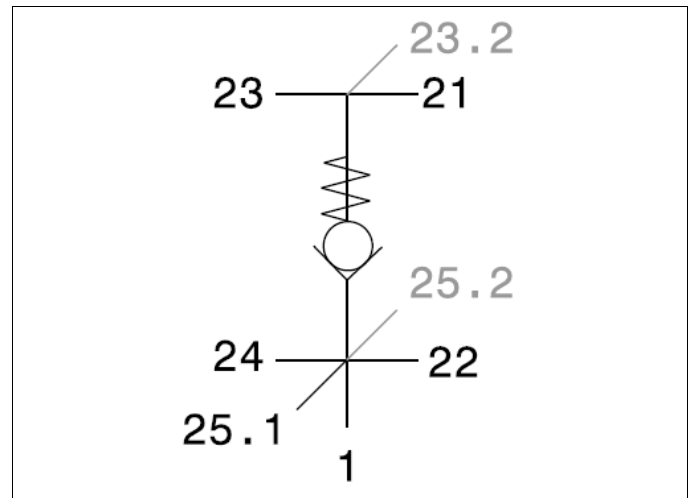
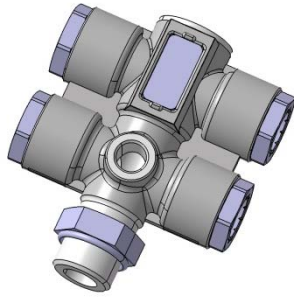

Part number	Connections	Opening pressure	Working press. (max)	Application temperature	Construction	Housing material	Sealing material	Application medium	Rem.
5232820670	1 Male thread M16x1.5 completed with hexagonal sealing nut and O-ring 21 Coupling SV232 NS12 22 Coupling SV232 NS12 23 Coupling SV232 NS12 24 Coupling SV232 NS12	0.2 bar	15.5 bar	-40°C to +100°C	Sealing disc	Aluminum forging	NBR	Compressed air	
5232820749	1 Male thread M22x1.5 21 Coupling SV232 NS12 22 Coupling SV232 NS12 23.2 Coupling SV232 NS12	0.2 bar	15.5 bar	-40°C to +100°C	Sealing disc	Aluminum forging	NBR	Compressed air	
5232820770	1 Male thread M22x1.5 completed with hexagonal sealing nut and O-ring 21 Coupling SV232 NS12 22 Coupling SV232 NS12 23.2 Coupling SV232 NS12	0.2 bar	15.5 bar	-40°C to +100°C	Sealing disc	Aluminum forging	NBR	Compressed air	
5232822170	1 Male thread M22x1.5 completed with hexagonal sealing nut and O-ring 22 Coupling SV232 NS12 23 Coupling SV232 NS12 24 Coupling SV232 NS12	0.3 bar	15.5 bar	-40°C to +100°C	Sealing disc	Aluminum forging	NBR	Compressed air	

B. Non-return valves

6. Non-return valve cartridges

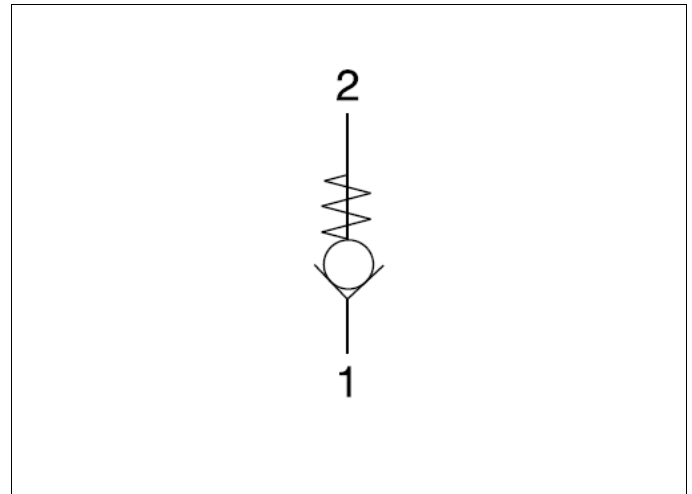

Part number	Connections	Opening pressure	Working press. (max)	Application temperature	Construction	Housing material	Sealing material	Application medium	Rem.
0605212000	1 Inlet port ID13 2 Male thread M27x1.5	10 bar	20 bar	-40°C to +130°C	Tappet	Steel	Metallically sealing	Hydraulic oils on the basis of mineral oil	
0605222000	1 Inlet port ID13 2 Male thread M27x1.5 with 40° centering taper	10 bar	20 bar	-40°C to +130°C	Tappet	Steel	Metallically sealing	Hydraulic oils on the basis of mineral oil	
0605502020	1 Inlet port ID4 2 Press-in diameter D13	0.2 bar	20 bar	-40°C to +120°C	Tappet	Steel	Metallically sealing	Hydraulic oils on the basis of mineral oil	

C. Multi-port valves

1. Two-way valves

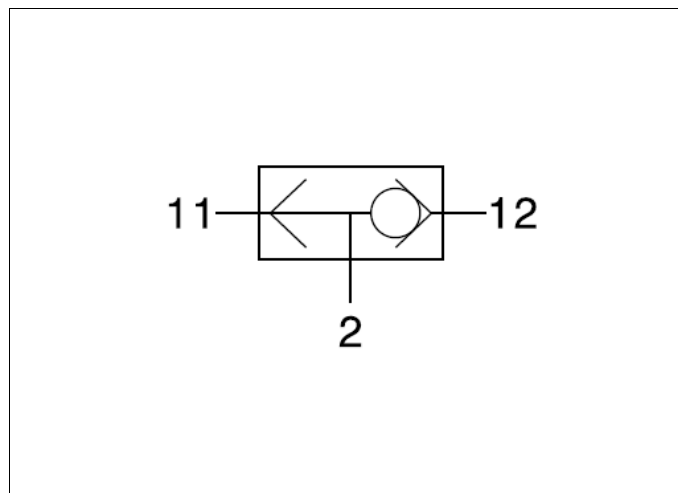
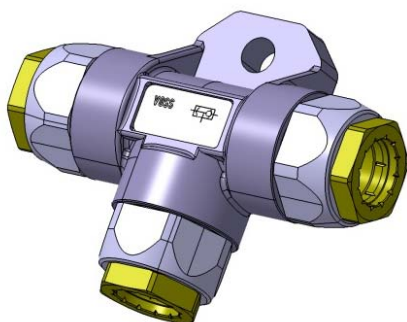

Part number	Connections	Differential closing press.	Working press. (max)	Application temperature	Construction	Housing material	Piston material	Application medium	Rem.
0233134200	2 Coupling SV230 NS12 11 Coupling SV230 NS12 12 Coupling SV230 NS12	0.15 bar	12 bar	-40°C to +100°C	Sealing piston	Zinc die-cast	FMQ	Compressed air	
0233294200	2 Profiled bore SV230/232 NS8 M16x1.5 11 Profiled bore SV230/232 NS8 M16x1.5 12 Profiled bore SV230/232 NS8 M16x1.5	0.15 bar	12 bar	-40°C to +100°C	Sealing piston	Zinc die-cast	FMQ	Compressed air	
0233294249	2 Coupling SV230 NS8 11 Coupling SV230 NS8 12 Coupling SV230 NS8	0.15 bar	12 bar	-40°C to +100°C	Sealing piston	Zinc die-cast	FMQ	Compressed air	
0233364200	2 Female thread M22x1.5 11 Profiled bore SV230/232 NS12 M22x1.5 12 Profiled bore SV230/232 NS12 M22x1.5	0.15 bar	12 bar	-40°C to +100°C	Sealing piston	Zinc die-cast	FMQ	Compressed air	
0833134200	2 Profiled bore SV230/232 NS12 M22x1.5 11 Profiled bore SV230/232 NS12 M22x1.5 12 Profiled bore SV230/232 NS12 M22x1.5	0.15 bar	12 bar	-40°C to +100°C	Sealing piston	Zinc die-cast	FMQ	Compressed air	
5232820100	2 Coupling SV232 NS12 11 Coupling SV232 NS12 12 Coupling SV232 NS12	0.15 bar	15.5 bar	-40°C to +100°C	Sealing piston	Zinc die-cast	FMQ	Compressed air	
5690004000	2 Female thread M22x1.5 11 Female thread M22x1.5 12 Female thread M22x1.5	0.15 bar	12 bar	-40°C to +100°C	Sealing piston	Zinc die-cast	FMQ	Compressed air	
5690031400	2 Female thread M12x1.5 11 Female thread M12x1.5 12 Female thread M12x1.5	0.15 bar	12 bar	-40°C to +100°C	Sealing piston	Zinc die-cast	FMQ	Compressed air	

C. Multi-port valves

2. Two-way valves with spring

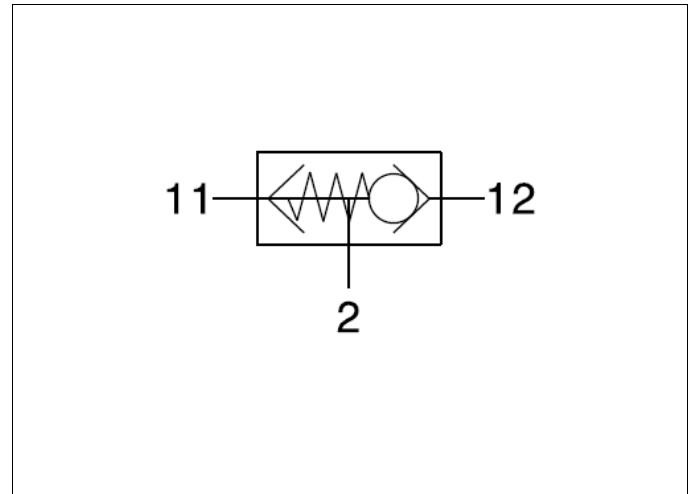
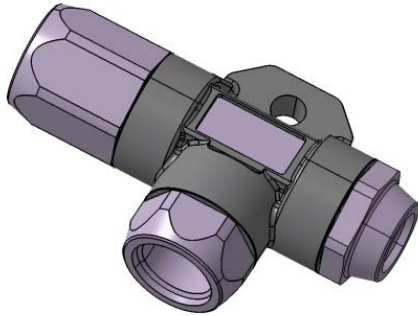

Part number	Connections	Opening press. connection 12	Working press. (max)	Application temperature	Construction	Housing material	Piston material	Application medium	Rem.
0233284200	2 Female thread M22x1.5 11 Profiled bore SV230/232 NS12 M22x1.5 12 Profiled bore SV230/232 NS8 M16x1.5	0.1 bar	12 bar	-40°C to +100°C	Sealing piston with spring	Zinc die-cast	FMQ	Compressed air	
5690011400	2 Female thread M22x1.5 11 Female thread M22x1.5 12 Female thread M16x1.5	0.1 bar	12 bar	-40°C to +100°C	Sealing piston with spring	Zinc die-cast	FMQ	Compressed air	

C. Multi-port valves

3. Six-way switch valves

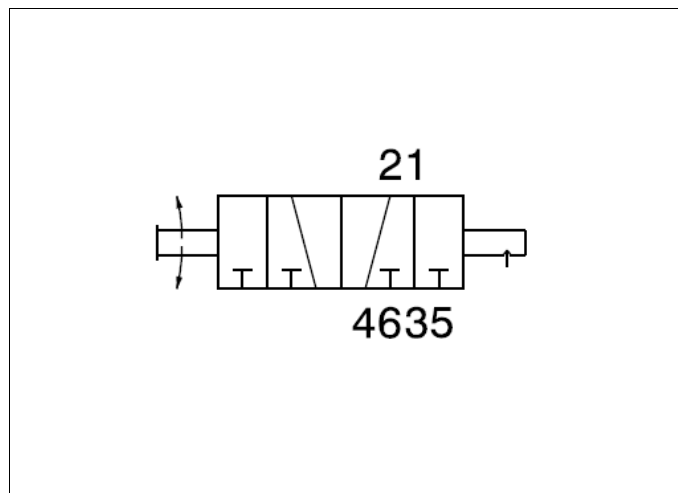
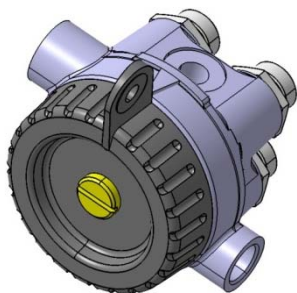

Part number	Connections	Working press. (max)	Application temperature	Construction	Housing material	Sealing material	Application medium	Rem.
5690027500	1 Female thread M18x1.5 2 Female thread M16x1.5 3 Cutting ring L10 M16x1.5 4 Cutting ring L10 M16x1.5 5 Cutting ring L10 M16x1.5 6 Cutting ring L10 M16x1.5	10 bar	-30°C to +100°C	Mechanically operated sealing disc	Aluminum forging	FPM	Diesel fuel	
5690027400	1 Female thread M18x1.5 2 Female thread M16x1.5 3 Cutting ring L12 M18x1.5 4 Cutting ring L10 M16x1.5 5 Cutting ring L12 M18x1.5 6 Cutting ring L10 M16x1.5	10 bar	-30°C to +100°C	Mechanically operated sealing disc	Aluminum forging	FPM	Diesel fuel	
5690027900	1 Female thread M18x1.5 2 Female thread M16x1.5 3 Cutting ring L12 M18x1.5 4 Cutting ring L12 M18x1.5 5 Cutting ring L12 M18x1.5 6 Cutting ring L12 M18x1.5	10 bar	-30°C to +100°C	Mechanically operated sealing disc	Aluminum forging	FPM	Diesel fuel	
5690027800	1 Profile SV246 NS12 2 Profile SV246 NS12 3 Profile SV246 NS12 4 Profile SV246 NS12 5 Profile SV246 NS12 6 Profile SV246 NS12	10 bar	-30°C to +100°C	Mechanically operated sealing disc	Aluminum forging	FPM	Diesel fuel	

D. Test and filling valves

1. Test and filling connections with screw-in thread, part 1

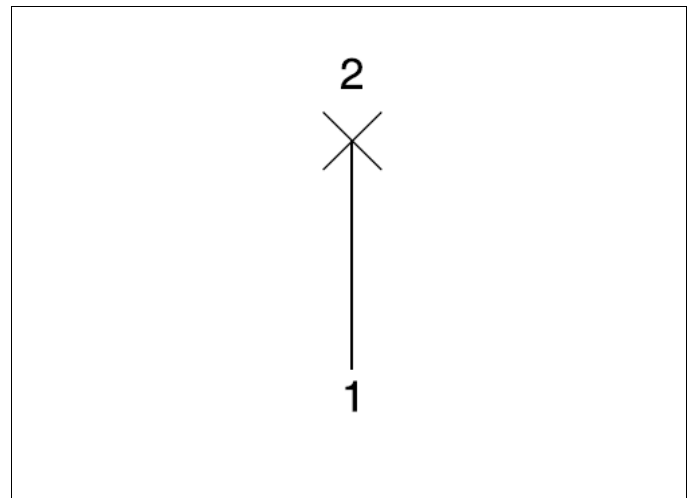

Part number	Connections	Working press. (max)	Application temperature	Construction	Housing material	Sealing material	Application medium	Rem.
0258595000	1 Male thread M12x1.5 AF17 Sealing for copper ring to DIN 3852 Form A 2 Test point M16x1.5	20 bar	-40°C to +100°C	Tappet with O-ring	Brass	NBR	Compressed air	
0268435000	1 Male thread M16x1.5 AF22 Sealing for copper ring to DIN 3852 Form A 2 Test point M16x1.5	20 bar	-40°C to +100°C	Tappet with O-ring	Brass	NBR	Compressed air	
0268435068	1 Male thread M16x1.5 AF22 Sealing with pressure ring and O-ring 2 Test point M16x1.5	20 bar	-40°C to +100°C	Tappet with O-ring	Brass	NBR	Compressed air	
0268235000	1 Male thread M16x1.5 AF22 O-ring sealing with angular O-ring groove 2 Test point M16x1.5	20 bar	-40°C to +100°C	Tappet with O-ring	Brass	NBR	Compressed air	
0233625000	1 Bulkhead thread M16x1.5 AF19 2 Test point M16x1.5	20 bar	-40°C to +100°C	Tappet with O-ring	Brass	NBR	Compressed air	
0268195000	1 Male thread M22x1.5 AF24 Sealing with O-ring for profiled bore SV230/232 2 Test point M16x1.5	20 bar	-40°C to +100°C	Tappet with O-ring	Brass	NBR	Compressed air	
0268445000	1 Male thread M22x1.5 AF27 Sealing for copper ring to DIN 3852 Form A 2 Test point M16x1.5	20 bar	-40°C to +100°C	Tappet with O-ring	Brass	NBR	Compressed air	
0268445068	1 Male thread M22x1.5 AF27 Sealing with pressure ring and O-ring 2 Test point M16x1.5	20 bar	-40°C to +100°C	Tappet with O-ring	Brass	NBR	Compressed air	

D. Test and filling valves

1. Test and filling connections with screw-in thread, part 2

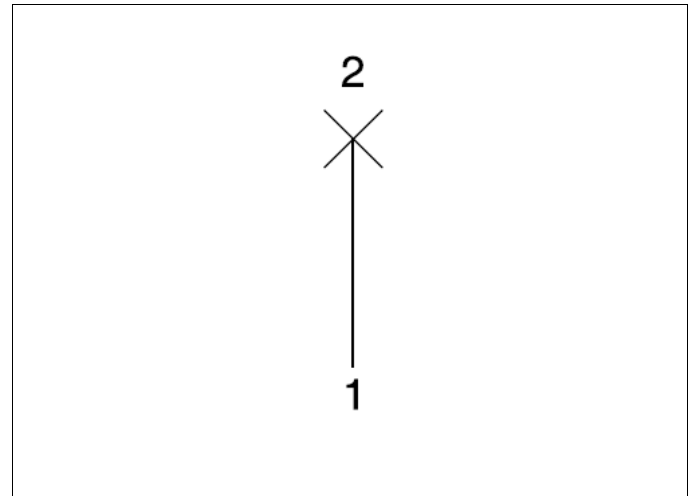

Part number	Connections	Working press. (max)	Application temperature	Construction	Housing material	Sealing material	Application medium	Rem.
0258575000	1 Male thread M22x1.5 AF27 O-ring sealing with angular O-ring groove	20 bar	-40°C to +100°C	Tappet with O-ring	Brass	NBR	Compressed air	
	2 Test point M16x1.5							
0268455000	1 Male thread 1/4" NPT	20 bar	-40°C to +100°C	Tappet with O-ring	Brass	NBR	Compressed air	
	2 Test point M16x1.5							

D. Test and filling valves

2. Test and filling connections with screw-on thread, part 1

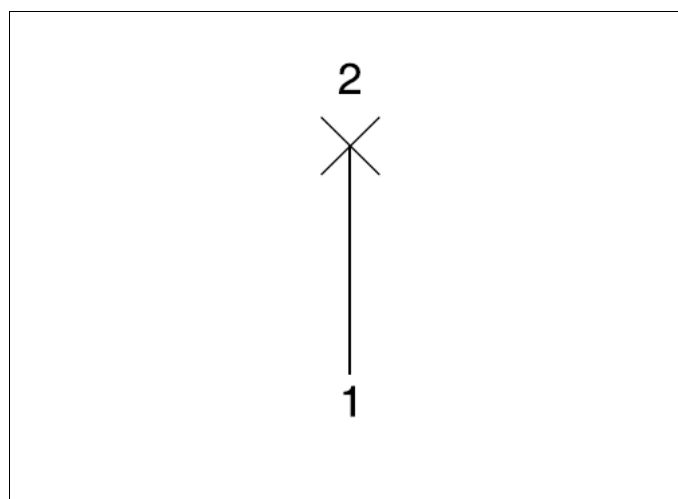
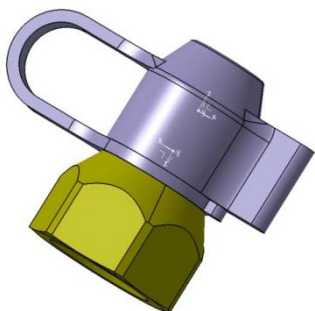

Part number	Connections	Working press. (max)	Application temperature	Construction	Housing material	Sealing material	Application medium	Rem.
0268305000	1 Female thread M12x1.5 AF17 Sealing with copper sealing washer 2 Test point M16x1.5	20 bar	-40°C to +100°C	Tappet with O-ring	Brass	NBR	Compressed air	
0258965000	1 Female thread M12x1.5 AF17 Sealing with copper sealing washer 2 Test point M16x1.5	12 bar	-40°C to +150°C	Tappet with O-ring	Brass	EPDM	Compressed air	1)
0268315000	1 Female thread M14x1.5 AF17 Sealing with copper sealing washer 2 Test point M16x1.5	20 bar	-40°C to +100°C	Tappet with O-ring	Brass	NBR	Compressed air	
0268325000	1 Female thread M16x1.5 AF22 Sealing with copper sealing washer 2 Test point M16x1.5	20 bar	-40°C to +100°C	Tappet with O-ring	Brass	NBR	Compressed air	
0278005000	1 Female thread M16x1.5 AF22 Sealing with copper sealing washer 2 Test point M16x1.5	12 bar	-40°C to +150°C	Tappet with O-ring	Brass	EPDM	Compressed air	1)
0278042000	1 Banjo bolt M10x1 AF17 2 Test point M16x1.5	12 bar	-40°C to +150°C	Tappet with O-ring	Steel	EPDM	Compressed air	1)
0268335000	1 Female thread M18x1.5 AF24 Sealing with copper sealing washer 2 Test point M16x1.5	20 bar	-40°C to +100°C	Tappet with O-ring	Brass	NBR	Compressed air	
0268065000	1 Female thread M18x1.5 AF24 Sealing with copper sealing washer 2 Test point M16x1.5	20 bar	-40°C to +100°C	Tappet with O-ring	Brass	NBR	Compressed air	2)

1) for application in hot areas, piston made of brass

2) filling valve with larger cross-section

D. Test and filling valves

2. Test and filling connections with screw-on thread, part 2

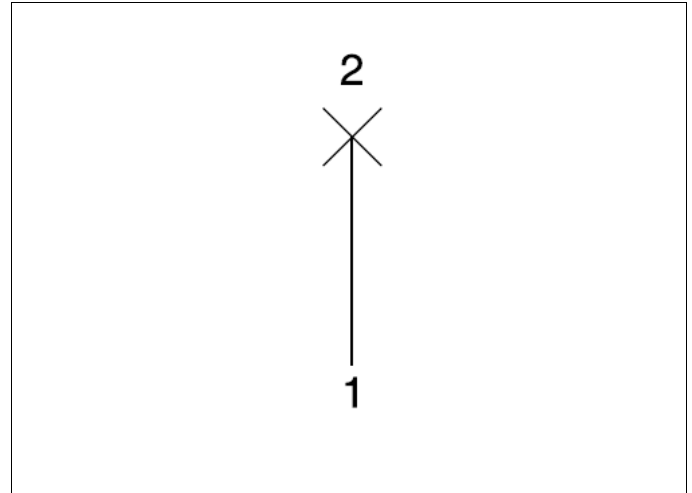
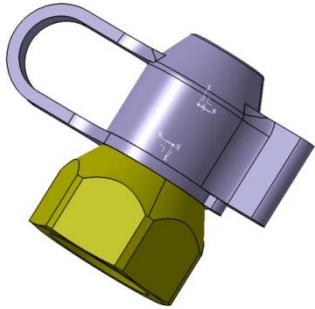

Part number	Connections	Working press. (max)	Application temperature	Construction	Housing material	Sealing material	Application medium	Rem.
0268345000	1 Female thread M22x1.5 AF27 Sealing with copper sealing washer 2 Test point M16x1.5	20 bar	-40°C to +100°C	Tappet with O-ring	Brass	NBR	Compressed air	
0268495000	1 Female thread M22x1.5 AF27 Sealing with copper sealing washer 2 Test point M16x1.5	20 bar	-40°C to +100°C	Tappet with O-ring	Brass	NBR	Compressed air	1)
0268935000	1 Female thread M22x1.5 AF27 Sealing with copper sealing washer 2 Test point M16x1.5	12 bar	-40°C to +150°C	Tappet with O-ring	Brass	EPDM	Compressed air	2)

1) filling valve with larger cross-section

2) for application in hot areas, piston made of brass

D. Test and filling valves

3. Straight quick connect system parts with test and filling connection

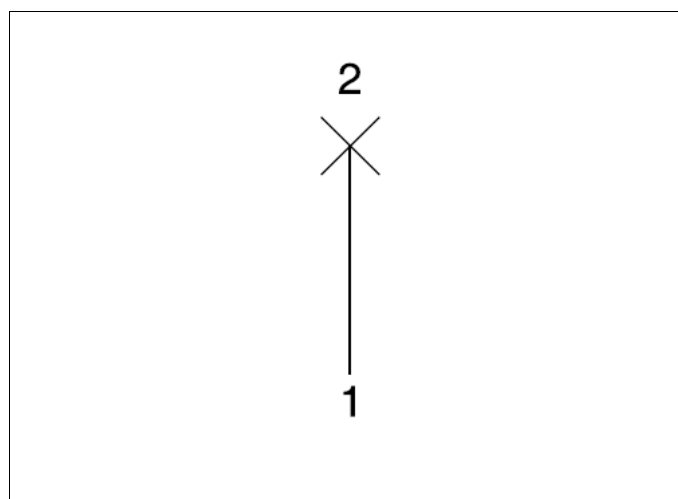

Part number	Connections	Working press. (max)	Application temperature	Construction	Housing material	Sealing material	Application medium	Rem.
5203988200	1 Assembly SV203 NS6 NBR and bulkhead thread M16x1.5 2 Test point M16x1.5	12 bar	-40°C to +100°C	Tappet with O-ring	Brass	NBR	Compressed air	
5203609500	1 Assembly SV203 NS6 EPDM and bulkhead thread M16x1.5 2 Test point M16x1.5	12 bar	-40°C to +100°C	Tappet with O-ring	Brass	NBR	Compressed air	
5203013300	1 Assembly SV203 NS6 EPDM/EPDM and bulkhead thread M16x1.5 2 Test point M16x1.5	12 bar	-40°C to +100°C	Tappet with O-ring	Brass	NBR	Compressed air	
5208994400	1 Assembly SV208 NS10 EPDM and bulkhead thread M22x1.5 2 Test point M16x1.5	12 bar	-40°C to +100°C	Tappet with O-ring	Brass	NBR	Compressed air	
0233625049	1 Coupling SV230 NS6 and bulkhead thread M16x1.5 2 Test point M16x1.5	12 bar	-40°C to +100°C	Tappet with O-ring	Brass	NBR	Compressed air	
5232801900	1 Coupling SV232 NS8 and bulkhead thread M24x1.5 2 Test point M16x1.5	15.5 bar	-40°C to +100°C	Tappet with O-ring	Brass	NBR	Compressed air	
5232801800	1 Coupling SV232 NS8 and bulkhead thread M24x1.5 2 Test point M16x1.5	15.5 bar	-40°C to +100°C	Tappet with O-ring	Brass	NBR	Compressed air	1)
0233015000	1 Plug SV230 NS12 2 Test point M16x1.5	12 bar	-40°C to +100°C	Tappet with O-ring	Brass	NBR	Compressed air	
0243085000	1 Coupling SV240 NS13 2 Test point M16x1.5	12 bar	-40°C to +100°C	Tappet with O-ring	Brass	NBR	Compressed air	

1) Filling valve with red cap

D. Test and filling valves

4. Test and filling valves with several branches, part 1

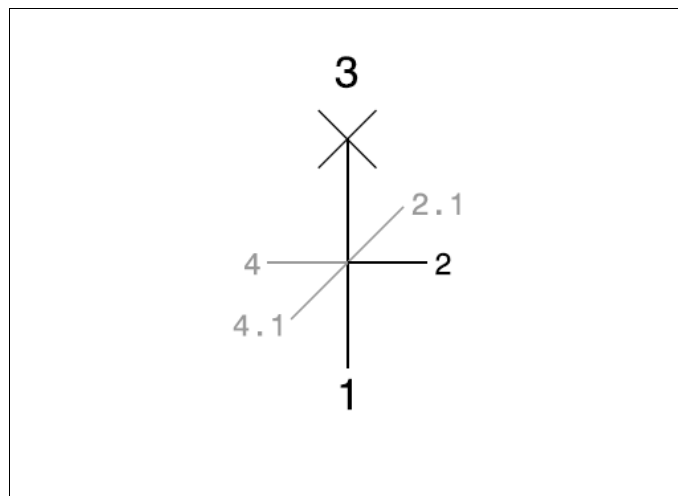

Part number	Connections	Working press. (max)	Application temperature	Construction	Housing material	Sealing material	Application medium	Rem.
0233195000	1 Plug SV230 NS8	12 bar	-40°C to +100°C	Tappet with O-ring	Brass	NBR	Compressed air	
	2 Fir-tree NS4							
	3 Test point M16x1.5							
0233205000	1 Plug SV230 NS8	12 bar	-40°C to +100°C	Tappet with O-ring	Brass	NBR	Compressed air	
	2 Fir-tree NS6							
	3 Test point M16x1.5							
0233505000	1 Plug SV230 NS8	12 bar	-40°C to +100°C	Tappet with O-ring	Brass	NBR	Compressed air	
	2 Test point M16x1.5							
	3 Assembly SV203 NS6 NBR							
0233235000	1 Plug SV230 NS12	12 bar	-40°C to +100°C	Tappet with O-ring	Brass	NBR	Compressed air	
	2 Fir-tree NS9							
	3 Test point M16x1.5							
0233515100	1 Plug SV230 NS12	12 bar	-40°C to +100°C	Tappet with O-ring	Brass	NBR	Compressed air	
	2 Fir-tree NS9							
	2.1 Fir-tree NS6 60°							
	3 Test point M16x1.5							
0233525000	1 Plug SV230 NS12	12 bar	-40°C to +100°C	Tappet with O-ring	Brass	NBR	Compressed air	
	2 Test point M16x1.5							
	3 Fir-tree NS9							
0233535000	1 Plug SV230 NS12	12 bar	-40°C to +100°C	Tappet with O-ring	Brass	NBR	Compressed air	
	2 Test point M16x1.5							
	3 Fir-tree NS9							
0233555100	1 Plug SV230 NS12	12 bar	-40°C to +100°C	Tappet with O-ring	Brass	NBR	Compressed air	
	2 Fir-tree NS9							
	4 Female thread M12x1.5							
	4.1 Test point M16x1.5 90°							

D. Test and filling valves

4. Test and filling valves with several branches, part 2

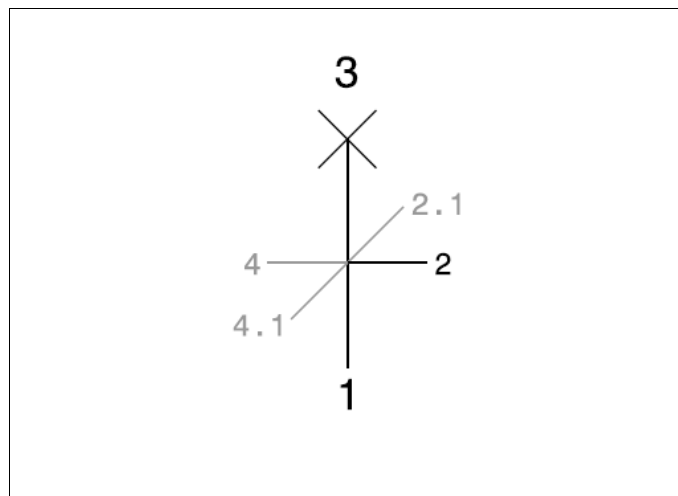

Part number	Connections	Working press. (max)	Application temperature	Construction	Housing material	Sealing material	Application medium	Rem.
0233585000	1 Plug SV230 NS12 2 Test point M16x1.5 4 Female thread M12x1.5 4.1 Fir-tree NS9 90°	12 bar	-40°C to +100°C	Tappet with O-ring	Brass	NBR	Compressed air	
0233595000	1 Plug SV230 NS12 2 Female thread M12x1.5 4 Test point M16x1.5 4.1 Fir-tree NS9 90°	12 bar	-40°C to +100°C	Tappet with O-ring	Brass	NBR	Compressed air	
5232801300	1 Plug SV232 NS8 2 Fir-tree NS6 3 Test point M16x1.5	15.5 bar	-40°C to +100°C	Tappet with O-ring	Brass	NBR	Compressed air	
5232802300	1 Plug SV232 NS8 2 Test point M16x1.5 4 Fir-tree NS6	15.5 bar	-40°C to +100°C	Tappet with O-ring	Brass	NBR	Compressed air	
5232800200	1 Plug SV232 NS8 2 Test point M16x1.5 4 Assembly SV203 NS6 NBR	15.5 bar	-40°C to +100°C	Tappet with O-ring	Brass	NBR	Compressed air	
5232801600	1 Plug SV232 NS12 2 Fir-tree NS6 3 Test point M16x1.5	15.5 bar	-40°C to +100°C	Tappet with O-ring	Brass	NBR	Compressed air	
5232800000	1 Plug SV232 NS12 2 Fir-tree NS9 3 Test point M16x1.5	15.5 bar	-40°C to +100°C	Tappet with O-ring	Brass	NBR	Compressed air	
5232800300	1 Plug SV232 NS12 2 Test point M16x1.5 3 Fir-tree NS9	15.5 bar	-40°C to +100°C	Tappet with O-ring	Brass	NBR	Compressed air	
5232800100	1 Plug SV232 NS12 2 Test point M16x1.5 4 Fir-tree NS9	15.5 bar	-40°C to +100°C	Tappet with O-ring	Brass	NBR	Compressed air	

D. Test and filling valves

4. Test and filling valves with several branches, part 3

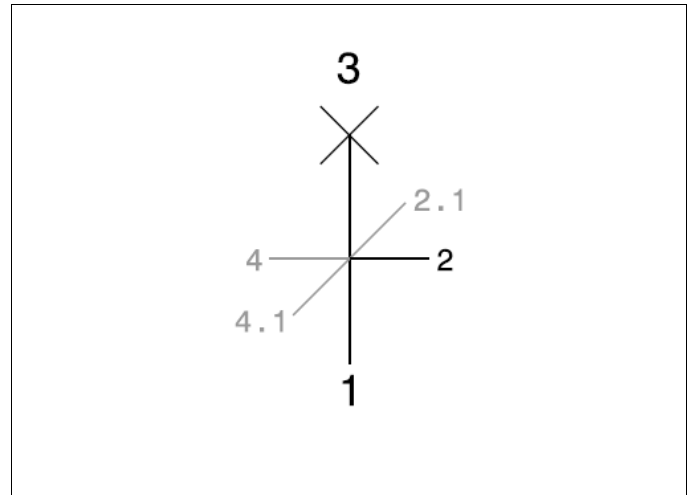

Part number	Connections	Working press. (max)	Application temperature	Construction	Housing material	Sealing material	Application medium	Rem.
5232801700	1 Plug SV232 NS12 with anti-twist 2 Test point M16x1.5 3 Hose connection DN11	15.5 bar	-40°C to +100°C	Tappet with O-ring	Brass	NBR	Compressed air	
5232800500	1 Plug SV232 NS12 2 Test point M16x1.5 4 Female thread M12x1.5 4.1 Fir-tree NS9 90°	15.5 bar	-40°C to +100°C	Tappet with O-ring	Brass	NBR	Compressed air	
5232800600	1 Plug SV232 NS12 2 Female thread M12x1.5 4 Test point M16x1.5 4.1 Fir-tree NS9 90°	15.5 bar	-40°C to +100°C	Tappet with O-ring	Brass	NBR	Compressed air	
5232802500	1 Plug SV232 NS12 2 Test point M16x1.5 3 Fir-tree NS9 4.1 Fir-tree NS9 90°	15.5 bar	-40°C to +100°C	Tappet with O-ring	Brass	NBR	Compressed air	
5232802600	1 Plug SV232 NS12 2 Fir-tree NS9 2.1 Fir-tree NS9 60° 3 Test point M16x1.5	15.5 bar	-40°C to +100°C	Tappet with O-ring	Brass	NBR	Compressed air	
5232802800	1 Plug SV232 NS12 with bulkhead thread M20x1.5 2 Test point M16x1.5 3 Hose connection DN11	15.5 bar	-40°C to +100°C	Tappet with O-ring	Brass	NBR	Compressed air	
5232821200	1 Plug SV232 NS12 2 Female thread M12x1.5 2.1 Fir-tree NS9 90° 3 Test point M16x1.5	15.5 bar	-40°C to +100°C	Tappet with O-ring	Brass	NBR	Compressed air	

D. Test and filling valves

4. Test and filling valves with several branches, part 4

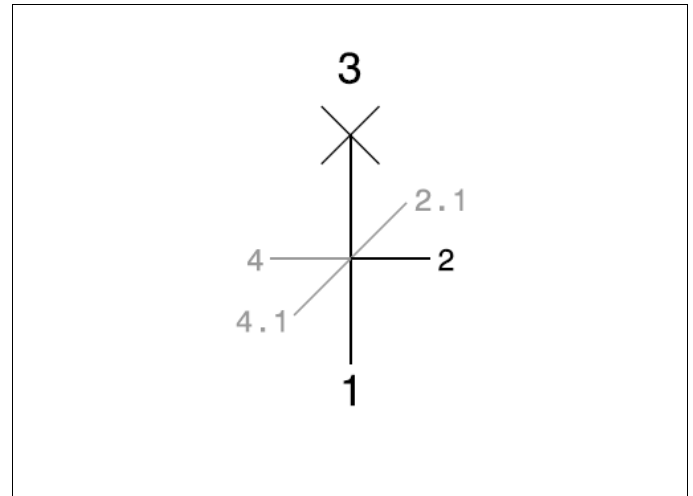
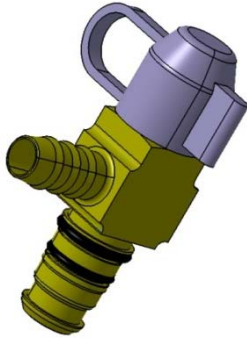

Part number	Connections	Working press. (max)	Application temperature	Construction	Housing material	Sealing material	Application medium	Rem.
5232802900	1 Male thread M22x1.5 completely with hexagonal sealing nut	15.5 bar	-40°C to +100°C	Tappet with O-ring	Brass	NBR	Compressed air	
	2 Coupling SV232 NS12							
	4.1 Screw-in test point M16x1.5							
5232803000	1 Male thread M22x1.5 completely with hexagonal sealing nut	15.5 bar	-40°C to +100°C	Tappet with O-ring	Brass	NBR	Compressed air	
	2 Screw-in test point M16x1.5							
	4.1 Coupling SV232 NS12							

D. Test and filling valves

5. Emergency release connections

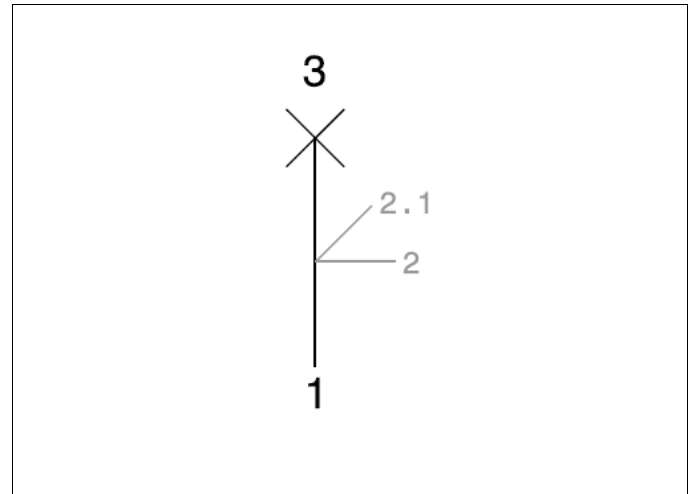

Part number	Connections	Working press. (max)	Application temperature	Construction	Housing material	Sealing material	Application medium	Rem.
0268415000	<ul style="list-style-type: none"> 1 Female thread M12x1.5 Sealing with copper sealing washer 3 Test point M16x1.5 with red emergency release cap 	20 bar	-40°C to +100°C	Tappet with O-ring	Brass	NBR	Compressed air	
0268405000	<ul style="list-style-type: none"> 1 Fir-tree NS6 3 Test point M16x1.5 with red emergency release cap 	20 bar	-40°C to +100°C	Tappet with O-ring	Brass	NBR	Compressed air	
5232802700	<ul style="list-style-type: none"> 1 Plug SV232 NS12 2 Fir-tree NS9 2.1 Fir-tree NS9 60° 3 Test point M16x1.5 	15.5 bar	-40°C to +100°C	Tappet with O-ring	Brass	NBR	Compressed air	

D. Test and filling valves

6. Test valves

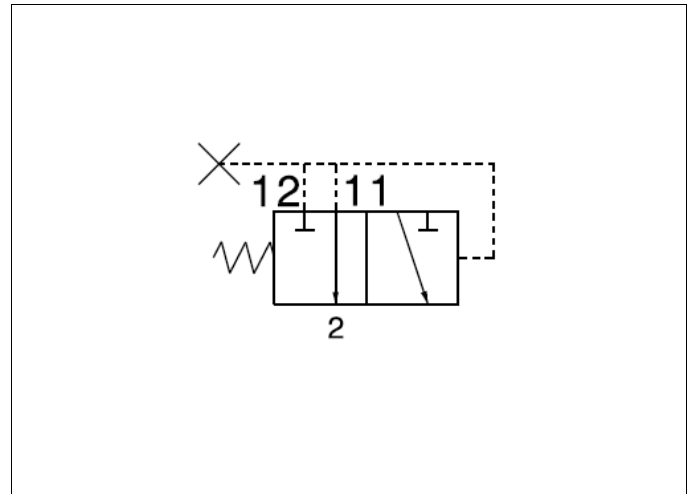
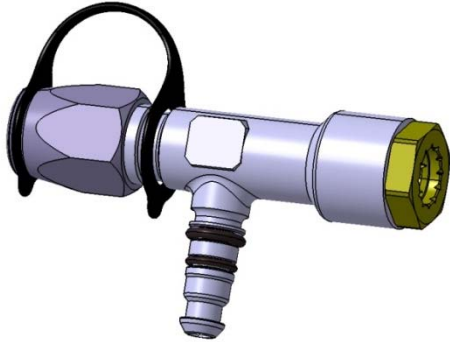

Part number	Connections	Working press. (max)	Application temperature	Construction	Housing material	Sealing material	Application medium	Rem.
0233085000	<ul style="list-style-type: none"> 2 Plug SV230 NS8 11 Coupling SV230 NS8 12 Test point M16x1.5 	12 bar	-40°C to +100°C	Tappet with O-ring	Brass	NBR	Compressed air	
5232801400	<ul style="list-style-type: none"> 2 Plug SV230 NS8 11 Profiled bore SV230/232 NS8 12 Test point M16x1.5 	15.5 bar	-40°C to +100°C	Tappet with O-ring	Brass	NBR	Compressed air	
5232801449	<ul style="list-style-type: none"> 2 Plug SV232 NS8 11 Coupling SV232 NS8 12 Test point M16x1.5 	15.5 bar	-40°C to +100°C	Tappet with O-ring	Brass	NBR	Compressed air	

E. Drain valves

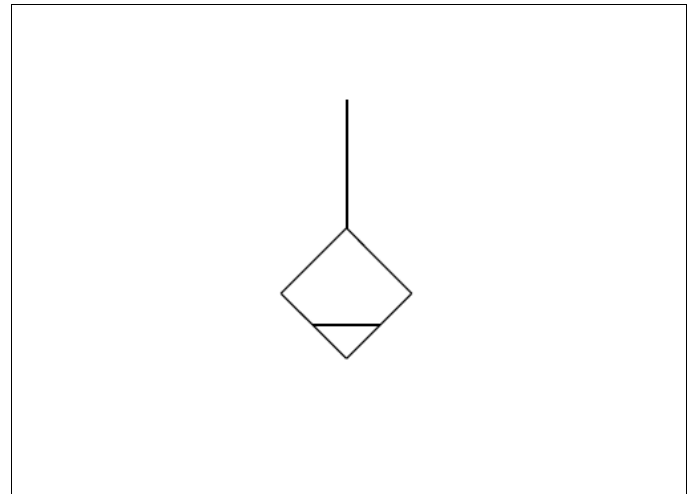

Part number	Connections	Working press. (max)	Application temperature	Construction	Housing material	Sealing material	Application medium	Rem.
0258255000	Male thread M22x1.5 AF24 Sealing with O-ring for profiled bore SV230 with pull ring	20 bar	-40°C to +100°C	Tappet with profile sealing	Brass	NBR	Compressed air	
0258825050	Male thread M22x1.5 AF27 Sealing for copper ring	20 bar	-40°C to +100°C	Tappet with profile sealing	Brass	NBR	Compressed air	
0258825000	Male thread M22x1.5 AF27 Sealing for copper ring with pull ring	20 bar	-40°C to +100°C	Tappet with profile sealing	Brass	NBR	Compressed air	
0258855052	Male thread M22x1.5 AF27 O-ring sealing with angular O-ring groove	20 bar	-40°C to +100°C	Tappet with profile sealing	Brass	NBR	Compressed air	
0258865052	Male thread M22x1.5 AF27 O-ring sealing with angular O-ring groove, with pull ring	20 bar	-40°C to +100°C	Tappet with profile sealing	Brass	NBR	Compressed air	
0258825068	Male thread M22x1.5 AF27 Sealing with pressure ring and O-ring with pull ring	20 bar	-40°C to +100°C	Tappet with profile sealing	Brass	NBR	Compressed air	
5208997500	Male thread M22x1.5 AF28 O-ring sealing on the face side	20 bar	-40°C to +100°C	Tappet with profile sealing	Brass	NBR	Compressed air	

F. Special valves

1. Pressure relief valve for hydraulic motor

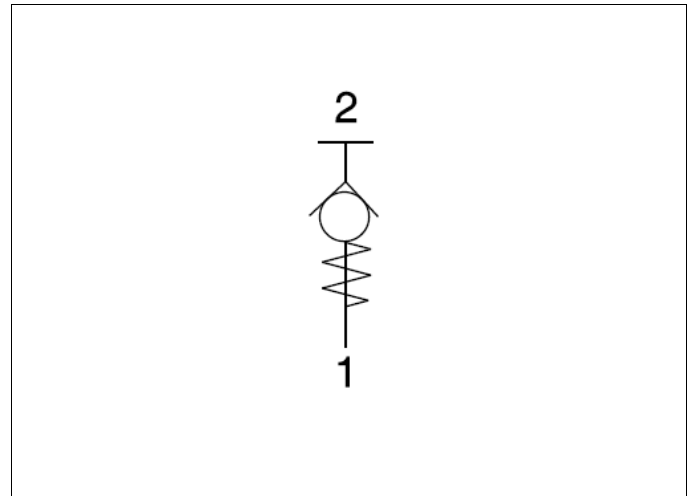
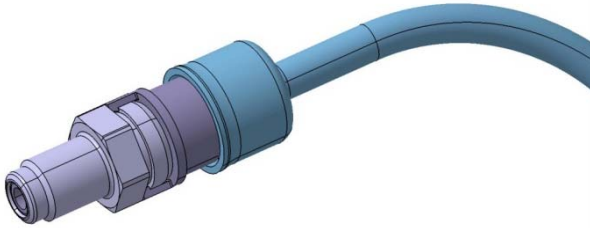

Part number	Connections	Working pressure connection 1	Application temperature	Construction	Housing material	Sealing material	Application medium	Rem.
5203987000	1 Male thread M10x1 2 Assembly SV203 NS4 NBR	500 bar	-40°C to +110°C	Valve cartridge	Brass	Metallically sealing	Hydraulic oil	
5300020500	1 Male thread M10x1 2 Connection bore ID10 with filter unit and evacuation cap	500 bar	-40°C to +110°C	Valve cartridge	Brass	Metallically sealing	Hydraulic oil	

F. Special valves

2. Pressure control valve for air suspension

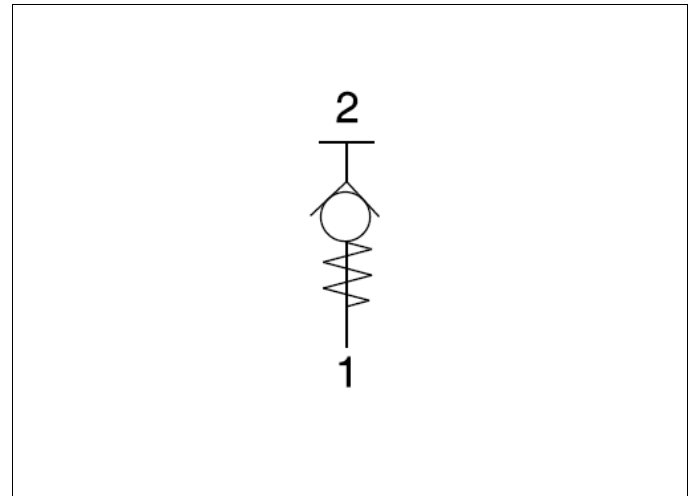
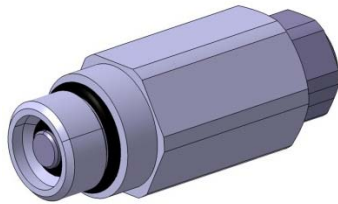

Part number	Connections	Working press. (max)	Application temperature	Construction	Housing material	Sealing material	Application medium	Rem.
5203985000	1 Male thread M12x1 Sealing with O-ring for profiled bore SV203 NS6	18 bar	-20°C to +100°C	Tappet with O-ring	Tin-coated brass	NBR	Compressed air	
	2 Assembly SV203 NS6 EPDM/EPDM							

F. Special valves

3. Regulating valve for cooling water

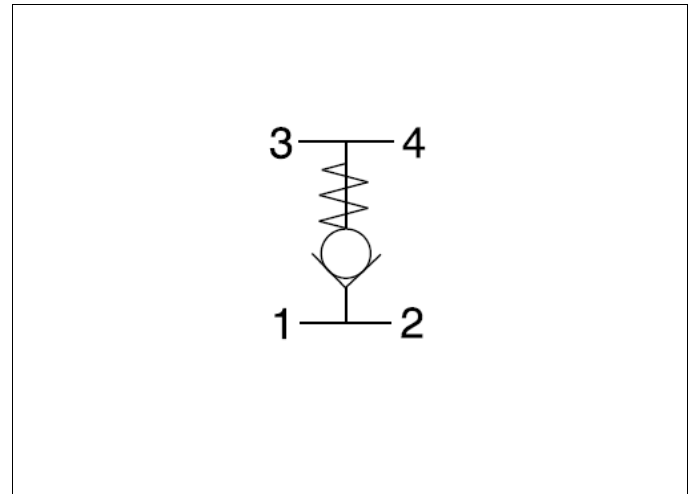
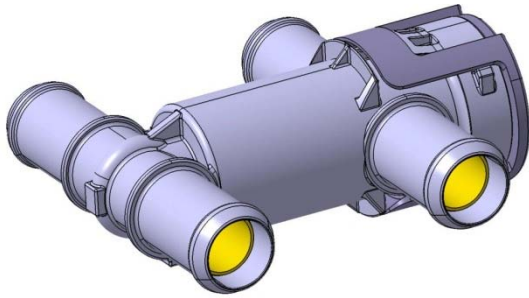

Part number	Connections	Opening pressure	Working press. (max)	Application temperature	Construction	Housing material	Sealing material	Application medium	Rem.
5467000200	<ul style="list-style-type: none"> 1 Hose nozzle DN19 2 Hose nozzle DN19 3 Hose nozzle DN19 4 Hose nozzle DN19 	0.4 bar	4.5 bar	-40°C to +125°C	Piston with elastomer sealing	Nylon	EPDM	Cooling water	

F. Special valves

4. SAE supply connection

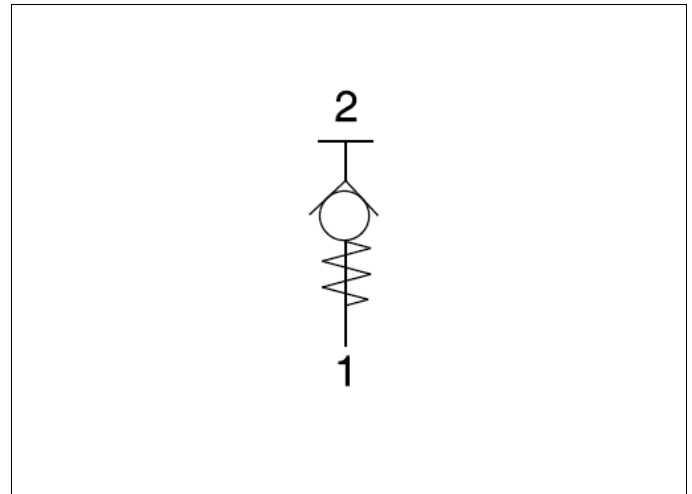
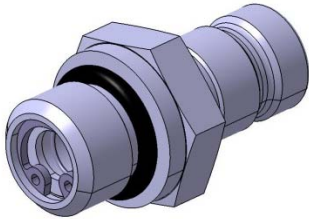

Part number	Connections	Working press. (max)	Application temperature	Construction	Housing material	Sealing material	Application medium	Rem.
0671512000	1 Male thread M14x1.5 with O-ring sealing according to ISO 6149	50 bar	-30°C to +140°C	Tappet with O-ring	Steel	FPM	Diesel fuel	
	2 Plug according to SAE J 1502-4 4.1							

Part number	Page	Part number	Page	Part number	Page	Part number	Page
0671423E13	7	0268335000	26	5203987000	36	5246031100	4
0671291E23	13	0268345000	26	5203988200	28	5246033900	3
0671410L00	7	0268405000	33	5208994400	28	5246036100	3
0671610L00	8	0268415000	33	5208997500	35	5246037300	3
0671630L00	12	0268435000	24	5232800000	30	5246038052	4
0671690D00	8	0268435068	24	5232800100	30	5246040349	4
0233015000	28	0268445000	24	5232800200	30	5246042900	4
0233085000	34	0268445068	24	5232800300	30	5246047649	4
0233124200	15	0268455000	25	5232800500	31	5246063900	3
0233134200	21	0268495000	27	5232800600	31	5246066200	10
0233195000	29	0268734200	16	5232801300	30	5246066800	11
0233205000	29	0268904200	16	5232801400	34	5300020500	36
0233235000	29	0268935000	27	5232801449	34	5466000600	6
0233255000	10	0278005000	26	5232801600	30	5466001600	6
0233264200	15	0278042000	26	5232801700	31	5466002500	5
0233284200	22	0600942081	8	5232801800	28	5466029149	6
0233294200	21	0600962000	8	5232801900	28	5466071200	5
0233294249	21	0601322007	7	5232802300	30	5466087900	9
0233304200	15	0605212000	20	5232802500	31	5466095500	5
0233314249	15	0605222000	20	5232802600	31	5466095600	5
0233324249	16	0605502020	20	5232802700	33	5466118400	5
0233334200	16	0660242000	12	5232802800	31	5466186800	5
0233364200	21	0660252000	12	5232802900	32	5466208800	5
0233505000	29	0667012081	8	5232803000	32	5466208900	5
0233515100	29	0667382081	7	5232820049	10	5467000200	38
0233525000	29	0667522007	8	5232820070	10	5690004000	21
0233535000	29	0668662000	8	5232820100	21	5690011400	22
0233555100	29	0669462000	13	5232820249	17	5690020300	7
0233585000	30	0669522081	8	5232820270	17	5690021300	12
0233595000	30	0669732018	13	5232820300	17	5690021400	12
0233625000	24	0669862020	9	5232820449	18	5690027400	23
0233625049	28	0670192020	9	5232820470	18	5690027500	23
0243085000	28	0670202020	9	5232820500	18	5690027800	23
0258255000	35	0670502020	7	5232820570	18	5690027900	23
0258575000	25	0670512000	12	5232820670	19	5690031400	21
0258595000	24	0670942000	13	5232820749	19		
0258825000	35	0670992000	12	5232820770	19		
0258825050	35	0671012023	13	5232821049	10		
0258825068	35	0671182023	13	5232821149	10		
0258855052	35	0671512000	39	5232821200	31		
0258865052	35	0671522000	14	5232821400	10		
0258965000	26	0671672000	14	5232822170	19		
0268065000	26	0671832020	7	5232993100	10		
0268195000	24	0833124200	17	5246013000	3		
0268235000	24	0833134200	21	5246014649	4		
0268305000	26	5203013300	28	5246016249	4		
0268315000	26	5203609500	28	5246021800	3		
0268325000	26	5203985000	37	5246030700	4		



Contact

VOSS Automotive, Inc.
4640 Hillegas Road
Fort Wayne, IN 46818
USA
Phone: +1 260-373-2277
customersvc@us.voss.net
www.vossusa.com

VOSS Automotive GmbH
P.O. Box 15 40
51679 Wipperfürth
Leiersmühle 2-6
51688 Wipperfürth
Germany
Phone: +49 2267 63-0
Fax: +49 2267 63-5982
automotive@voss.net
www.voss-automotive.net